

# ***MPS/MSL***

**Innovative flute geometry and  
wave type cutting edge.  
Multi-purpose drills for precise and  
efficient machining.**

■ L/D = 3 ~ 30 available.

## ***MSL***

Unique wave type cutting  
edge and special flute  
geometry for smooth chip  
evacuation.

**Continuous feed  
drilling of deep holes  
from L/D = 20 - 30.**

## ***MPS***

New type for high  
performance drilling.

**Double margin flute  
for high machining  
accuracy.**



# Solid Carbide Drill

# MPS/MSL

## Features

- Wave type cutting edge for superior drilling performance
- Double margin flute for higher accuracy holes (MPS type)
- MIRACLE coated VP15TF for longer tool life

Cutting edge shape

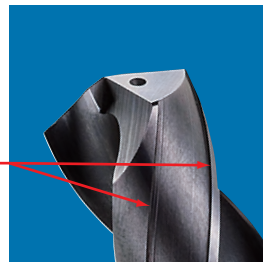
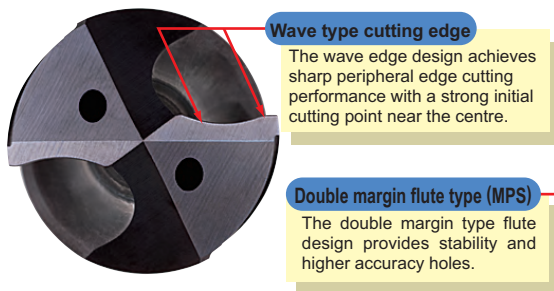

Cross sectional shape

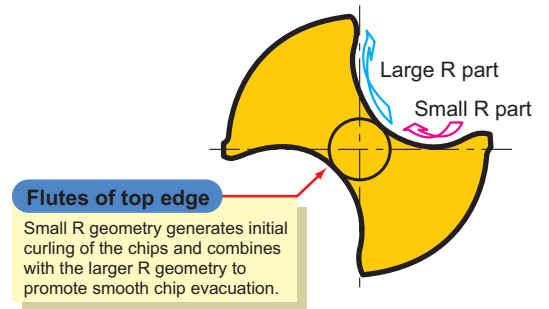

## Excellent chip discharge

A special geometry at the top of the flute allows for superior chip control.

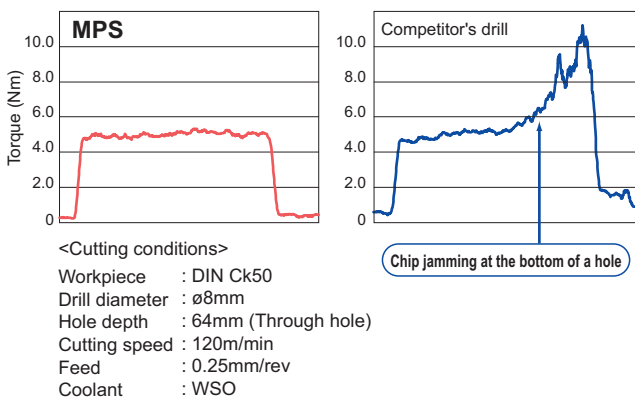

## Material technology

- Long tool life **MIRACLE**® coated **VP15TF**

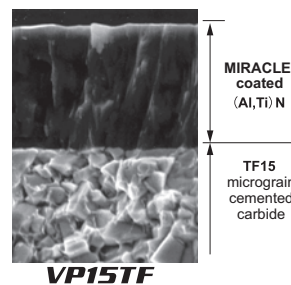

**MIRACLE**® Coated

**Features of VP15TF**

MIRACLE coated VP15TF is ideal for drilling due to its high resistance to chip welding. Suitable for machining a wide range of workpiece materials from Mild and Alloy steels through to Stainless steels and Cast iron.

## A wide selection of drills

The range includes drills for hole depths from L/D = 3 - 30.

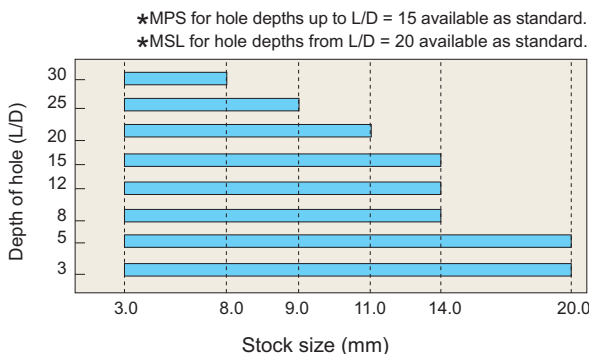

## Long Tool Life

The special cutting edge geometry and advanced material technology provide high durability.

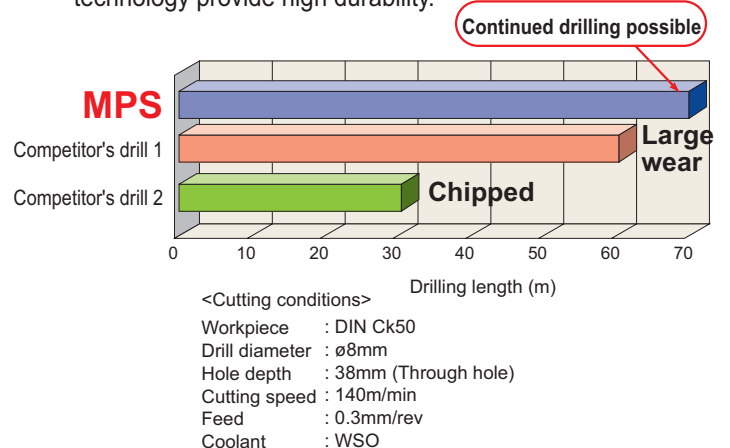

# Cutting Performance

## High accuracy (Roundness)

MPS MSL drills for hole roundness accuracy.

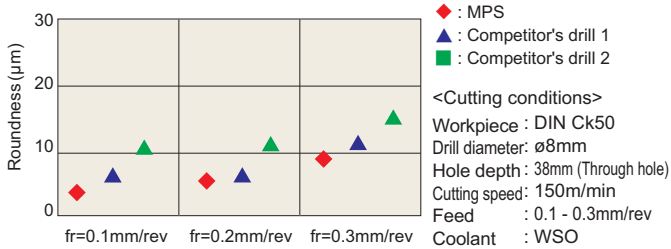

## High accuracy (Actual hole diameter)

The special cutting edge geometry and material technology ensures accurate hole sizes.

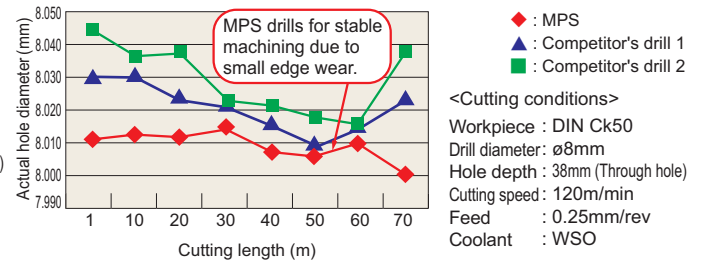

## High accuracy (Surface roughness)

MPS/MSL drills for superior hole surface finishes.

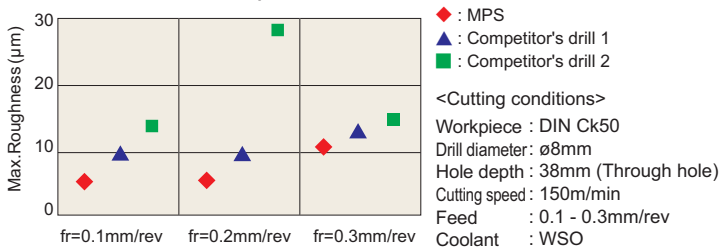

# Solid Carbide Drill

## MPS/MSL



D1 Tolerance	3.0 ≤ D1 ≤ 6.0	6.0 < D1 ≤ 10.0	10.0 < D1 ≤ 18.0	18.0 < D1 ≤ 20.0
DIN type	0.010 -0.002	0.010 -0.005	0.005 -0.013	0.005 -0.016
Others	0 -0.012	0 -0.015	0 -0.018	0 -0.021

\* MPS-DIN type see table above. Other MPS/MSL drills h7 tolerance.

### ● Type A Double margin type

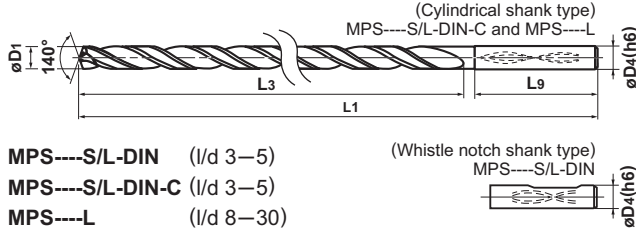

MPS---S/L-DIN (l/d 3-5)

MPS---S/L-DIN-C (l/d 3-5)

MPS---L (l/d 8-30)

### ● Type B Standard margin type



MSL (l/d 20-30)

Drill Dia. D1 (mm)	Hole Depth (l/d)	Stock VP15TF	Order Number	Dimensions (mm)				Type
				L1	L3	L9	D4	
3.0	3	●	MPS0300S-DIN	62	20	36	6	A
	3	●	MPS0300S-DIN-C	62	20	36	6	A
	5	●	MPS0300L-DIN	66	28	36	6	A
	5	●	MPS0300L-DIN-C	66	28	36	6	A
	8	●	MPS0300-L8C	74	34	36	6	A
	10	□	MPS0300-L10C	80	40	36	6	A
	12	●	MPS0300-L12C	86	46	36	6	A
	15	●	MPS0300-L15C	95	55	36	6	A
	20	□	MPS0300-L20C	110	70	36	6	A
	25	□	MPS0300-L25C	125	85	36	6	A
	30	□	MPS0300-L30C	140	100	36	6	A
	20	●	MSL0300-L20C	110	70	36	6	B
25	●	MSL0300-L25C	125	85	36	6	B	
30	●	MSL0300-L30C	140	100	36	6	B	
3.05	3	●	MPS0305S-DIN	62	20	36	6	A
	3	●	MPS0305S-DIN-C	62	20	36	6	A
	5	●	MPS0305L-DIN	66	28	36	6	A
	5	●	MPS0305L-DIN-C	66	28	36	6	A
3.1	3	●	MPS0310S-DIN	62	20	36	6	A
	3	●	MPS0310S-DIN-C	62	20	36	6	A
	5	●	MPS0310L-DIN	66	28	36	6	A
	5	●	MPS0310L-DIN-C	66	28	36	6	A
	8	●	MPS0310-L8C	80	40	36	6	A
	10	□	MPS0310-L10C	87	47	36	6	A
	12	●	MPS0310-L12C	94	54	36	6	A
	15	●	MPS0310-L15C	104	64	36	6	A
	20	□	MPS0310-L20C	122	82	36	6	A
	25	□	MPS0310-L25C	139	99	36	6	A
	30	□	MPS0310-L30C	157	117	36	6	A
	20	●	MSL0310-L20C	122	82	36	6	B
25	●	MSL0310-L25C	139	99	36	6	B	
30	●	MSL0310-L30C	157	117	36	6	B	
3.2	3	●	MPS0320S-DIN	62	20	36	6	A
	3	●	MPS0320S-DIN-C	62	20	36	6	A
	5	●	MPS0320L-DIN	66	28	36	6	A
	5	●	MPS0320L-DIN-C	66	28	36	6	A
	8	●	MPS0320-L8C	80	40	36	6	A
	10	□	MPS0320-L10C	87	47	36	6	A
	12	●	MPS0320-L12C	94	54	36	6	A
	15	●	MPS0320-L15C	104	64	36	6	A
	20	□	MPS0320-L20C	122	82	36	6	A
	25	□	MPS0320-L25C	139	99	36	6	A
	30	□	MPS0320-L30C	157	117	36	6	A
	20	●	MSL0320-L20C	122	82	36	6	B
25	●	MSL0320-L25C	139	99	36	6	B	
30	●	MSL0320-L30C	157	117	36	6	B	

Drill Dia. D1 (mm)	Hole Depth (l/d)	Stock VP15TF	Order Number	Dimensions (mm)				Type
				L1	L3	L9	D4	
3.2	30	□	MPS0320-L30C	157	117	36	6	A
	20	●	MSL0320-L20C	122	82	36	6	B
	25	●	MSL0320-L25C	139	99	36	6	B
	30	●	MSL0320-L30C	157	117	36	6	B
3.3	3	●	MPS0330S-DIN	62	20	36	6	A
	3	●	MPS0330S-DIN-C	62	20	36	6	A
	5	●	MPS0330L-DIN	66	28	36	6	A
	5	●	MPS0330L-DIN-C	66	28	36	6	A
	8	●	MPS0330-L8C	80	40	36	6	A
	10	□	MPS0330-L10C	87	47	36	6	A
	12	●	MPS0330-L12C	94	54	36	6	A
	15	●	MPS0330-L15C	104	64	36	6	A
	20	□	MPS0330-L20C	122	82	36	6	A
	25	□	MPS0330-L25C	139	99	36	6	A
	30	□	MPS0330-L30C	157	117	36	6	A
	20	●	MSL0330-L20C	122	82	36	6	B
25	●	MSL0330-L25C	139	99	36	6	B	
30	●	MSL0330-L30C	157	117	36	6	B	
3.4	3	●	MPS0340S-DIN	62	20	36	6	A
	3	●	MPS0340S-DIN-C	62	20	36	6	A
	5	●	MPS0340L-DIN	66	28	36	6	A
	5	●	MPS0340L-DIN-C	66	28	36	6	A
	8	●	MPS0340-L8C	80	40	36	6	A
	10	□	MPS0340-L10C	87	47	36	6	A
	12	●	MPS0340-L12C	94	54	36	6	A
	15	●	MPS0340-L15C	104	64	36	6	A
	20	□	MPS0340-L20C	122	82	36	6	A
	25	□	MPS0340-L25C	139	99	36	6	A
	30	□	MPS0340-L30C	157	117	36	6	A
	20	●	MSL0340-L20C	122	82	36	6	B
25	●	MSL0340-L25C	139	99	36	6	B	
30	●	MSL0340-L30C	157	117	36	6	B	



Drill Dia. D1 (mm)	Hole Depth (l/d)	Stock		Order Number	Dimensions (mm)				Type
		VP15TF			L1	L3	L9	D4	
3.5	3	●		MPS0350S-DIN	62	20	36	6	A
	3	●		MPS0350S-DIN-C	62	20	36	6	A
	5	●		MPS0350L-DIN	66	28	36	6	A
	5	●		MPS0350L-DIN-C	66	28	36	6	A
	8	●		MPS0350-L8C	80	40	36	6	A
	10	□		MPS0350-L10C	87	47	36	6	A
	12	●		MPS0350-L12C	94	54	36	6	A
	15	●		MPS0350-L15C	104	64	36	6	A
	20	□		MPS0350-L20C	122	82	36	6	A
	25	□		MPS0350-L25C	139	99	36	6	A
	30	□		MPS0350-L30C	157	117	36	6	A
	20	●		MSL0350-L20C	122	82	36	6	B
	25	●		MSL0350-L25C	139	99	36	6	B
	30	●		MSL0350-L30C	157	117	36	6	B
3.6	3	●		MPS0360S-DIN	62	20	36	6	A
	3	●		MPS0360S-DIN-C	62	20	36	6	A
	5	●		MPS0360L-DIN	66	28	36	6	A
	5	●		MPS0360L-DIN-C	66	28	36	6	A
	8	●		MPS0360-L8C	85	45	36	6	A
	10	□		MPS0360-L10C	93	53	36	6	A
	12	●		MPS0360-L12C	101	61	36	6	A
	15	●		MPS0360-L15C	113	73	36	6	A
	20	□		MPS0360-L20C	133	93	36	6	A
	25	□		MPS0360-L25C	153	113	36	6	A
	30	□		MPS0360-L30C	173	133	36	6	A
	20	●		MSL0360-L20C	133	93	36	6	B
	25	●		MSL0360-L25C	153	113	36	6	B
	30	●		MSL0360-L30C	173	133	36	6	B
3.7	3	●		MPS0370S-DIN	62	20	36	6	A
	3	●		MPS0370S-DIN-C	62	20	36	6	A
	5	●		MPS0370L-DIN	66	28	36	6	A
	5	●		MPS0370L-DIN-C	66	28	36	6	A
	8	●		MPS0370-L8C	85	45	36	6	A
	10	□		MPS0370-L10C	93	53	36	6	A
	12	●		MPS0370-L12C	101	61	36	6	A
	15	●		MPS0370-L15C	113	73	36	6	A
	20	□		MPS0370-L20C	133	93	36	6	A
	25	□		MPS0370-L25C	153	113	36	6	A
	30	□		MPS0370-L30C	173	133	36	6	A
	20	●		MSL0370-L20C	133	93	36	6	B
	25	●		MSL0370-L25C	153	113	36	6	B
	30	●		MSL0370-L30C	173	133	36	6	B
3.8	3	●		MPS0380S-DIN	66	24	36	6	A
	3	●		MPS0380S-DIN-C	66	24	36	6	A
	5	●		MPS0380L-DIN	74	36	36	6	A
	5	●		MPS0380L-DIN-C	74	36	36	6	A
	8	●		MPS0380-L8C	85	45	36	6	A
	10	□		MPS0380-L10C	93	53	36	6	A
	12	●		MPS0380-L12C	101	61	36	6	A
	15	●		MPS0380-L15C	113	73	36	6	A
	20	□		MPS0380-L20C	133	93	36	6	A
	25	□		MPS0380-L25C	153	113	36	6	A
	30	□		MPS0380-L30C	173	133	36	6	A
	20	●		MSL0380-L20C	133	93	36	6	B
	25	●		MSL0380-L25C	153	113	36	6	B
	30	●		MSL0380-L30C	173	133	36	6	B

Drill Dia. D1 (mm)	Hole Depth (l/d)	Stock		Order Number	Dimensions (mm)				Type
		VP15TF			L1	L3	L9	D4	
3.9	3	●		MPS0390S-DIN	66	24	36	6	A
	3	●		MPS0390S-DIN-C	66	24	36	6	A
	5	●		MPS0390L-DIN	74	36	36	6	A
	5	●		MPS0390L-DIN-C	74	36	36	6	A
	8	●		MPS0390-L8C	85	45	36	6	A
	10	□		MPS0390-L10C	93	53	36	6	A
	12	●		MPS0390-L12C	101	61	36	6	A
	15	●		MPS0390-L15C	113	73	36	6	A
	20	□		MPS0390-L20C	133	93	36	6	A
	25	□		MPS0390-L25C	153	113	36	6	A
	30	□		MPS0390-L30C	173	133	36	6	A
	20	●		MSL0390-L20C	133	93	36	6	B
	25	●		MSL0390-L25C	153	113	36	6	B
	30	●		MSL0390-L30C	173	133	36	6	B
4.0	3	●		MPS0400S-DIN	66	24	36	6	A
	3	●		MPS0400S-DIN-C	66	24	36	6	A
	5	●		MPS0400L-DIN	74	36	36	6	A
	5	●		MPS0400L-DIN-C	74	36	36	6	A
	8	●		MPS0400-L8C	85	45	36	6	A
	10	□		MPS0400-L10C	93	53	36	6	A
	12	●		MPS0400-L12C	101	61	36	6	A
	15	●		MPS0400-L15C	113	73	36	6	A
	20	□		MPS0400-L20C	133	93	36	6	A
	25	□		MPS0400-L25C	153	113	36	6	A
	30	□		MPS0400-L30C	173	133	36	6	A
	20	●		MSL0400-L20C	133	93	36	6	B
	25	●		MSL0400-L25C	153	113	36	6	B
	30	●		MSL0400-L30C	173	133	36	6	B
4.05	3	●		MPS0405S-DIN	66	24	36	6	A
	3	●		MPS0405S-DIN-C	66	24	36	6	A
	5	●		MPS0405L-DIN	74	36	36	6	A
	5	●		MPS0405L-DIN-C	74	36	36	6	A
	NEW	3	●		MPS0405S-DIN	66	24	36	6
4.1	3	●		MPS0410S-DIN	66	24	36	6	A
	3	●		MPS0410S-DIN-C	66	24	36	6	A
	5	●		MPS0410L-DIN	74	36	36	6	A
	5	●		MPS0410L-DIN-C	74	36	36	6	A
	8	●		MPS0410-L8C	91	51	36	6	A
	10	□		MPS0410-L10C	100	60	36	6	A
	12	●		MPS0410-L12C	109	69	36	6	A
	15	●		MPS0410-L15C	122	82	36	6	A
	20	□		MPS0410-L20C	145	105	36	6	A
	25	□		MPS0410-L25C	167	127	36	6	A
	30	□		MPS0410-L30C	190	150	36	6	A
	20	●		MSL0410-L20C	145	105	36	6	B
	25	●		MSL0410-L25C	167	127	36	6	B
	30	●		MSL0410-L30C	190	150	36	6	B



D1 Tolerance	3.0 ≤ D1 ≤ 6.0	6.0 < D1 ≤ 10.0	10.0 < D1 ≤ 18.0	18.0 < D1 ≤ 20.0
DIN type	0.010 -0.002	0.010 -0.005	0.005 -0.013	0.005 -0.016
Others	0 -0.012	0 -0.015	0 -0.018	0 -0.021

\* MPS-DIN type see table above. Other MPS/MSL drills h7 tolerance.

### ● Type A Double margin type

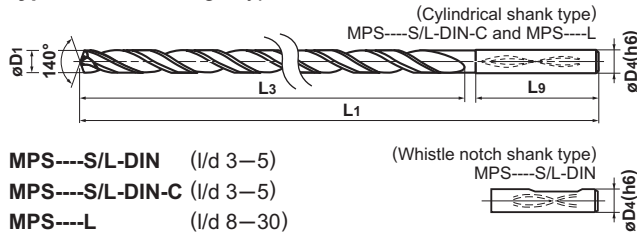

MPS---S/L-DIN (l/d 3-5)

MPS---S/L-DIN-C (l/d 3-5)

MPS---L (l/d 8-30)

### ● Type B Standard margin type



MSL (l/d 20-30)

Drill Dia. D1 (mm)	Hole Depth (l/d)	Stock VP15TF	Order Number	Dimensions (mm)				Type
				L1	L3	L9	D4	
4.2	3	●	MPS0420S-DIN	66	24	36	6	A
	3	●	MPS0420S-DIN-C	66	24	36	6	A
	5	●	MPS0420L-DIN	74	36	36	6	A
	5	●	MPS0420L-DIN-C	74	36	36	6	A
	8	●	MPS0420-L8C	91	51	36	6	A
	10	□	MPS0420-L10C	100	60	36	6	A
	12	●	MPS0420-L12C	109	69	36	6	A
	15	●	MPS0420-L15C	122	82	36	6	A
	20	□	MPS0420-L20C	145	105	36	6	A
	25	□	MPS0420-L25C	167	127	36	6	A
	30	□	MPS0420-L30C	190	150	36	6	A
	20	●	MSL0420-L20C	145	105	36	6	B
25	●	MSL0420-L25C	167	127	36	6	B	
30	●	MSL0420-L30C	190	150	36	6	B	
4.3	3	●	MPS0430S-DIN	66	24	36	6	A
	3	●	MPS0430S-DIN-C	66	24	36	6	A
	5	●	MPS0430L-DIN	74	36	36	6	A
	5	●	MPS0430L-DIN-C	74	36	36	6	A
	8	●	MPS0430-L8C	91	51	36	6	A
	10	□	MPS0430-L10C	100	60	36	6	A
	12	●	MPS0430-L12C	109	69	36	6	A
	15	●	MPS0430-L15C	122	82	36	6	A
	20	□	MPS0430-L20C	145	105	36	6	A
	25	□	MPS0430-L25C	167	127	36	6	A
	30	□	MPS0430-L30C	190	150	36	6	A
	20	●	MSL0430-L20C	145	105	36	6	B
25	●	MSL0430-L25C	167	127	36	6	B	
30	●	MSL0430-L30C	190	150	36	6	B	
4.4	3	●	MPS0440S-DIN	66	24	36	6	A
	3	●	MPS0440S-DIN-C	66	24	36	6	A
	5	●	MPS0440L-DIN	74	36	36	6	A
	5	●	MPS0440L-DIN-C	74	36	36	6	A
	8	●	MPS0440-L8C	91	51	36	6	A
	10	□	MPS0440-L10C	100	60	36	6	A
	12	●	MPS0440-L12C	109	69	36	6	A
	15	●	MPS0440-L15C	122	82	36	6	A
	20	□	MPS0440-L20C	145	105	36	6	A
	25	□	MPS0440-L25C	167	127	36	6	A
	30	□	MPS0440-L30C	190	150	36	6	A
	20	●	MSL0440-L20C	145	105	36	6	B
25	●	MSL0440-L25C	167	127	36	6	B	
30	●	MSL0440-L30C	190	150	36	6	B	

Drill Dia. D1 (mm)	Hole Depth (l/d)	Stock VP15TF	Order Number	Dimensions (mm)				Type
				L1	L3	L9	D4	
4.5	3	●	MPS0450S-DIN	66	24	36	6	A
	3	●	MPS0450S-DIN-C	66	24	36	6	A
	5	●	MPS0450L-DIN	74	36	36	6	A
	5	●	MPS0450L-DIN-C	74	36	36	6	A
	8	●	MPS0450-L8C	91	51	36	6	A
	10	□	MPS0450-L10C	100	60	36	6	A
	12	●	MPS0450-L12C	109	69	36	6	A
	15	●	MPS0450-L15C	122	82	36	6	A
	20	□	MPS0450-L20C	145	105	36	6	A
	25	□	MPS0450-L25C	167	127	36	6	A
	30	□	MPS0450-L30C	190	150	36	6	A
	20	●	MSL0450-L20C	145	105	36	6	B
25	●	MSL0450-L25C	167	127	36	6	B	
30	●	MSL0450-L30C	190	150	36	6	B	
4.6	3	●	MPS0460S-DIN	66	24	36	6	A
	3	●	MPS0460S-DIN-C	66	24	36	6	A
	5	●	MPS0460L-DIN	74	36	36	6	A
	5	●	MPS0460L-DIN-C	74	36	36	6	A
	8	●	MPS0460-L8C	96	55	36	6	A
	10	□	MPS0460-L10C	106	66	36	6	A
	12	●	MPS0460-L12C	116	76	36	6	A
	15	●	MPS0460-L15C	131	91	36	6	A
	20	□	MPS0460-L20C	156	116	36	6	A
	25	□	MPS0460-L25C	181	141	36	6	A
	30	□	MPS0460-L30C	206	166	36	6	A
	20	●	MSL0460-L20C	156	116	36	6	B
25	●	MSL0460-L25C	181	141	36	6	B	
30	●	MSL0460-L30C	206	166	36	6	B	
4.65	3	●	MPS0465S-DIN	66	24	36	6	A
	3	●	MPS0465S-DIN-C	66	24	36	6	A
	5	●	MPS0465L-DIN	74	36	36	6	A
	5	●	MPS0465L-DIN-C	74	36	36	6	A

Drill Dia. D1 (mm)	Hole Depth (l/d)	Stock		Order Number	Dimensions (mm)				Type
		VP15TF			L1	L3	L9	D4	
4.7	3	●		MPS0470S-DIN	66	24	36	6	A
	3	●		MPS0470S-DIN-C	66	24	36	6	A
	5	●		MPS0470L-DIN	74	36	36	6	A
	5	●		MPS0470L-DIN-C	74	36	36	6	A
	8	●		MPS0470-L8C	96	55	36	6	A
	10	□		MPS0470-L10C	106	66	36	6	A
	12	●		MPS0470-L12C	116	76	36	6	A
	15	●		MPS0470-L15C	131	91	36	6	A
	20	□		MPS0470-L20C	156	116	36	6	A
	25	□		MPS0470-L25C	181	141	36	6	A
	30	□		MPS0470-L30C	206	166	36	6	A
	20	●		MSL0470-L20C	156	116	36	6	B
	25	●		MSL0470-L25C	181	141	36	6	B
	30	●		MSL0470-L30C	206	166	36	6	B
4.8	3	●		MPS0480S-DIN	66	28	36	6	A
	3	●		MPS0480S-DIN-C	66	28	36	6	A
	5	●		MPS0480L-DIN	82	44	36	6	A
	5	●		MPS0480L-DIN-C	82	44	36	6	A
	8	●		MPS0480-L8C	96	55	36	6	A
	10	□		MPS0480-L10C	106	66	36	6	A
	12	●		MPS0480-L12C	116	76	36	6	A
	15	●		MPS0480-L15C	131	91	36	6	A
	20	□		MPS0480-L20C	156	116	36	6	A
	25	□		MPS0480-L25C	181	141	36	6	A
	30	□		MPS0480-L30C	206	166	36	6	A
	20	●		MSL0480-L20C	156	116	36	6	B
	25	●		MSL0480-L25C	181	141	36	6	B
	30	●		MSL0480-L30C	206	166	36	6	B
4.9	3	●		MPS0490S-DIN	66	28	36	6	A
	3	●		MPS0490S-DIN-C	66	28	36	6	A
	5	●		MPS0490L-DIN	82	44	36	6	A
	5	●		MPS0490L-DIN-C	82	44	36	6	A
	8	●		MPS0490-L8C	96	55	36	6	A
	10	□		MPS0490-L10C	106	66	36	6	A
	12	●		MPS0490-L12C	116	76	36	6	A
	15	●		MPS0490-L15C	131	91	36	6	A
	20	□		MPS0490-L20C	156	116	36	6	A
	25	□		MPS0490-L25C	181	141	36	6	A
	30	□		MPS0490-L30C	206	166	36	6	A
	20	●		MSL0490-L20C	156	116	36	6	B
	25	●		MSL0490-L25C	181	141	36	6	B
	30	●		MSL0490-L30C	206	166	36	6	B
5.0	3	●		MPS0500S-DIN	66	28	36	6	A
	3	●		MPS0500S-DIN-C	66	28	36	6	A
	5	●		MPS0500L-DIN	82	44	36	6	A
	5	●		MPS0500L-DIN-C	82	44	36	6	A
	8	●		MPS0500-L8C	96	55	36	6	A
	10	□		MPS0500-L10C	106	66	36	6	A
	12	●		MPS0500-L12C	116	76	36	6	A
	15	●		MPS0500-L15C	131	91	36	6	A
	20	□		MPS0500-L20C	156	116	36	6	A
	25	□		MPS0500-L25C	181	141	36	6	A
	30	□		MPS0500-L30C	206	166	36	6	A
	20	●		MSL0500-L20C	156	116	36	6	B
	25	●		MSL0500-L25C	181	141	36	6	B
	30	●		MSL0500-L30C	206	166	36	6	B

Drill Dia. D1 (mm)	Hole Depth (l/d)	Stock		Order Number	Dimensions (mm)				Type
		VP15TF			L1	L3	L9	D4	
5.05	3	●		MPS0505S-DIN	66	28	36	6	A
	3	●		MPS0505S-DIN-C	66	28	36	6	A
	5	●		MPS0505L-DIN	82	44	36	6	A
	5	●		MPS0505L-DIN-C	82	44	36	6	A
	NEW	5	●		MPS0505L-DIN-C	82	44	36	6
5.1	3	●		MPS0510S-DIN	66	28	36	6	A
	3	●		MPS0510S-DIN-C	66	28	36	6	A
	5	●		MPS0510L-DIN	82	44	36	6	A
	5	●		MPS0510L-DIN-C	82	44	36	6	A
	8	●		MPS0510-L8C	102	62	36	6	A
	10	□		MPS0510-L10C	113	73	36	6	A
	12	●		MPS0510-L12C	124	84	36	6	A
	15	●		MPS0510-L15C	140	100	36	6	A
	20	□		MPS0510-L20C	168	128	36	6	A
	25	□		MPS0510-L25C	195	155	36	6	A
	30	□		MPS0510-L30C	223	183	36	6	A
	20	●		MSL0510-L20C	168	128	36	6	B
	25	●		MSL0510-L25C	195	155	36	6	B
	30	●		MSL0510-L30C	223	183	36	6	B
5.2	3	●		MPS0520S-DIN	66	28	36	6	A
	3	●		MPS0520S-DIN-C	66	28	36	6	A
	5	●		MPS0520L-DIN	82	44	36	6	A
	5	●		MPS0520L-DIN-C	82	44	36	6	A
	8	●		MPS0520-L8C	102	62	36	6	A
	10	□		MPS0520-L10C	113	73	36	6	A
	12	●		MPS0520-L12C	124	84	36	6	A
	15	●		MPS0520-L15C	140	100	36	6	A
	20	□		MPS0520-L20C	168	128	36	6	A
	25	□		MPS0520-L25C	195	155	36	6	A
	30	□		MPS0520-L30C	223	183	36	6	A
	20	●		MSL0520-L20C	168	128	36	6	B
	25	●		MSL0520-L25C	195	155	36	6	B
	30	●		MSL0520-L30C	223	183	36	6	B
5.3	3	●		MPS0530S-DIN	66	28	36	6	A
	3	●		MPS0530S-DIN-C	66	28	36	6	A
	5	●		MPS0530L-DIN	82	44	36	6	A
	5	●		MPS0530L-DIN-C	82	44	36	6	A
	8	●		MPS0530-L8C	102	62	36	6	A
	10	□		MPS0530-L10C	113	73	36	6	A
	12	●		MPS0530-L12C	124	84	36	6	A
	15	●		MPS0530-L15C	140	100	36	6	A
	20	□		MPS0530-L20C	168	128	36	6	A
	25	□		MPS0530-L25C	195	155	36	6	A
	30	□		MPS0530-L30C	223	183	36	6	A
	20	●		MSL0530-L20C	168	128	36	6	B
	25	●		MSL0530-L25C	195	155	36	6	B
	30	●		MSL0530-L30C	223	183	36	6	B



D1 Tolerance	3.0 ≤ D1 ≤ 6.0	6.0 < D1 ≤ 10.0	10.0 < D1 ≤ 18.0	18.0 < D1 ≤ 20.0
DIN type	0.010 -0.002	0.010 -0.005	0.005 -0.013	0.005 -0.016
Others	0 -0.012	0 -0.015	0 -0.018	0 -0.021

\* MPS-DIN type see table above. Other MPS/MSL drills h7 tolerance.

### ● Type A Double margin type

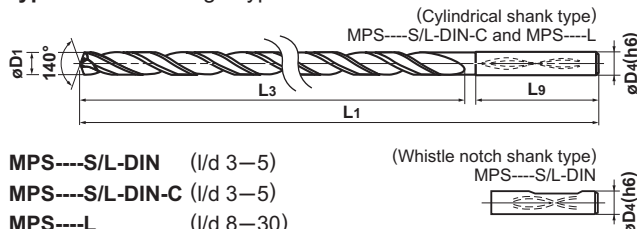

MPS---S/L-DIN (l/d 3-5)

MPS---S/L-DIN-C (l/d 3-5)

MPS---L (l/d 8-30)

### ● Type B Standard margin type



MSL (l/d 20-30)

Drill Dia. D1 (mm)	Hole Depth (l/d)	Stock VP15TF	Order Number	Dimensions (mm)				Type
				L1	L3	L9	D4	
5.4	3	●	MPS0540S-DIN	66	28	36	6	A
	3	●	MPS0540S-DIN-C	66	28	36	6	A
	5	●	MPS0540L-DIN	82	44	36	6	A
	5	●	MPS0540L-DIN-C	82	44	36	6	A
	8	●	MPS0540-L8C	102	62	36	6	A
	10	□	MPS0540-L10C	113	73	36	6	A
	12	●	MPS0540-L12C	124	84	36	6	A
	15	●	MPS0540-L15C	140	100	36	6	A
	20	□	MPS0540-L20C	168	128	36	6	A
	25	□	MPS0540-L25C	195	155	36	6	A
	30	□	MPS0540-L30C	223	183	36	6	A
	20	●	MSL0540-L20C	168	128	36	6	B
	25	●	MSL0540-L25C	195	155	36	6	B
30	●	MSL0540-L30C	223	183	36	6	B	
5.5	3	●	MPS0550S-DIN	66	28	36	6	A
	3	●	MPS0550S-DIN-C	66	28	36	6	A
	5	●	MPS0550L-DIN	82	44	36	6	A
	5	●	MPS0550L-DIN-C	82	44	36	6	A
	8	●	MPS0550-L8C	102	62	36	6	A
	10	□	MPS0550-L10C	113	73	36	6	A
	12	●	MPS0550-L12C	124	84	36	6	A
	15	●	MPS0550-L15C	140	100	36	6	A
	20	□	MPS0550-L20C	168	128	36	6	A
	25	□	MPS0550-L25C	195	155	36	6	A
	30	□	MPS0550-L30C	223	183	36	6	A
	20	●	MSL0550-L20C	168	128	36	6	B
	25	●	MSL0550-L25C	195	155	36	6	B
30	●	MSL0550-L30C	223	183	36	6	B	
5.55	3	●	MPS0555S-DIN	66	28	36	6	A
	3	●	MPS0555S-DIN-C	66	28	36	6	A
	5	●	MPS0555L-DIN	82	44	36	6	A
	5	●	MPS0555L-DIN-C	82	44	36	6	A
	5	●	MPS0555L-DIN-C	82	44	36	6	A
5.6	3	●	MPS0560S-DIN	66	28	36	6	A
	3	●	MPS0560S-DIN-C	66	28	36	6	A
	5	●	MPS0560L-DIN	82	44	36	6	A
	5	●	MPS0560L-DIN-C	82	44	36	6	A
	8	●	MPS0560-L8C	107	67	36	6	A
	10	□	MPS0560-L10C	119	79	36	6	A
	12	●	MPS0560-L12C	131	91	36	6	A
	15	●	MPS0560-L15C	149	109	36	6	A
	20	□	MPS0560-L20C	179	139	36	6	A
	25	□	MPS0560-L25C	209	169	36	6	A

Drill Dia. D1 (mm)	Hole Depth (l/d)	Stock VP15TF	Order Number	Dimensions (mm)				Type
				L1	L3	L9	D4	
5.6	30	□	MPS0560-L30C	239	199	36	6	A
	20	●	MSL0560-L20C	179	139	36	6	B
	25	●	MSL0560-L25C	209	169	36	6	B
	30	●	MSL0560-L30C	239	199	36	6	B
5.7	3	●	MPS0570S-DIN	66	28	36	6	A
	3	●	MPS0570S-DIN-C	66	28	36	6	A
	5	●	MPS0570L-DIN	82	44	36	6	A
	5	●	MPS0570L-DIN-C	82	44	36	6	A
	8	●	MPS0570-L8C	107	67	36	6	A
	10	□	MPS0570-L10C	119	79	36	6	A
	12	●	MPS0570-L12C	131	91	36	6	A
	15	●	MPS0570-L15C	149	109	36	6	A
	20	□	MPS0570-L20C	179	139	36	6	A
	25	□	MPS0570-L25C	209	169	36	6	A
	30	□	MPS0570-L30C	239	199	36	6	A
	20	●	MSL0570-L20C	179	139	36	6	B
	25	●	MSL0570-L25C	209	169	36	6	B
30	●	MSL0570-L30C	239	199	36	6	B	
5.8	3	●	MPS0580S-DIN	66	28	36	6	A
	3	●	MPS0580S-DIN-C	66	28	36	6	A
	5	●	MPS0580L-DIN	82	44	36	6	A
	5	●	MPS0580L-DIN-C	82	44	36	6	A
	8	●	MPS0580-L8C	107	67	36	6	A
	10	□	MPS0580-L10C	119	79	36	6	A
	12	●	MPS0580-L12C	131	91	36	6	A
	15	●	MPS0580-L15C	149	109	36	6	A
	20	□	MPS0580-L20C	179	139	36	6	A
	25	□	MPS0580-L25C	209	169	36	6	A
	30	□	MPS0580-L30C	239	199	36	6	A
	20	●	MSL0580-L20C	179	139	36	6	A
	25	●	MSL0580-L25C	209	169	36	6	B
30	●	MSL0580-L30C	239	199	36	6	B	
5.9	3	●	MPS0590S-DIN	66	28	36	6	A
	3	●	MPS0590S-DIN-C	66	28	36	6	A
	5	●	MPS0590L-DIN	82	44	36	6	A
	5	●	MPS0590L-DIN-C	82	44	36	6	A
	8	●	MPS0590-L8C	107	67	36	6	A
	10	□	MPS0590-L10C	119	79	36	6	A
	12	●	MPS0590-L12C	131	91	36	6	A
	15	●	MPS0590-L15C	149	109	36	6	A
	20	□	MPS0590-L20C	179	139	36	6	A
	25	□	MPS0590-L25C	209	169	36	6	A



Drill Dia. D1 (mm)	Hole Depth (l/d)	Stock		Order Number	Dimensions (mm)				Type
		VP15TF			L1	L3	L9	D4	
5.9	30	□		MPS0590-L30C	239	199	36	6	A
	20	●		MSL0590-L20C	179	139	36	6	B
	25	●		MSL0590-L25C	209	169	36	6	B
	30	●		MSL0590-L30C	239	199	36	6	B
6.0	3	●		MPS0600S-DIN	66	28	36	6	A
	3	●		MPS0600S-DIN-C	66	28	36	6	A
	5	●		MPS0600L-DIN	82	44	36	6	A
	5	●		MPS0600L-DIN-C	82	44	36	6	A
	8	●		MPS0600-L8C	107	67	36	6	A
	10	□		MPS0600-L10C	119	79	36	6	A
	12	●		MPS0600-L12C	131	91	36	6	A
	15	●		MPS0600-L15C	149	109	36	6	A
	20	□		MPS0600-L20C	179	139	36	6	A
	25	□		MPS0600-L25C	209	169	36	6	A
	30	□		MPS0600-L30C	239	199	36	6	A
		20	●		MSL0600-L20C	179	139	36	6
	25	●		MSL0600-L25C	209	169	36	6	B
	30	●		MSL0600-L30C	239	199	36	6	B
6.05	3	●		MPS0605S-DIN	79	34	36	8	A
	3	●		MPS0605S-DIN-C	79	34	36	8	A
	5	●		MPS0605L-DIN	91	53	36	8	A
	5	●		MPS0605L-DIN-C	91	53	36	8	A
6.1	3	●		MPS0610S-DIN	79	34	36	8	A
	3	●		MPS0610S-DIN-C	79	34	36	8	A
	5	●		MPS0610L-DIN	91	53	36	8	A
	5	●		MPS0610L-DIN-C	91	53	36	8	A
	8	●		MPS0610-L8C	113	73	36	8	A
	10	□		MPS0610-L10C	126	86	36	8	A
	12	●		MPS0610-L12C	139	99	36	8	A
	15	●		MPS0610-L15C	158	118	36	8	A
	20	□		MPS0610-L20C	191	151	36	8	A
	25	□		MPS0610-L25C	223	183	36	8	A
	30	□		MPS0610-L30C	256	216	36	8	A
		20	●		MSL0610-L20C	191	151	36	8
	25	●		MSL0610-L25C	223	183	36	8	B
	30	●		MSL0610-L30C	256	216	36	8	B
6.2	3	●		MPS0620S-DIN	79	34	36	8	A
	3	●		MPS0620S-DIN-C	79	34	36	8	A
	5	●		MPS0620L-DIN	91	53	36	8	A
	5	●		MPS0620L-DIN-C	91	53	36	8	A
	8	●		MPS0620-L8C	113	76	36	8	A
	10	□		MPS0620-L10C	126	86	36	8	A
	12	●		MPS0620-L12C	139	99	36	8	A
	15	●		MPS0620-L15C	158	118	36	8	A
	20	□		MPS0620-L20C	191	151	36	8	A
	25	□		MPS0620-L25C	223	183	36	8	A
	30	□		MPS0620-L30C	256	216	36	8	A
		20	●		MSL0620-L20C	191	151	36	8
	25	●		MSL0620-L25C	223	183	36	8	B
	30	●		MSL0620-L30C	256	216	36	8	B
6.3	3	●		MPS0630S-DIN	79	34	36	8	A
	3	●		MPS0630S-DIN-C	79	34	36	8	A
	5	●		MPS0630L-DIN	91	53	36	8	A
	5	●		MPS0630L-DIN-C	91	53	36	8	A
	8	●		MPS0630-L8C	113	73	36	8	A
	10	□		MPS0630-L10C	126	86	36	8	A

Drill Dia. D1 (mm)	Hole Depth (l/d)	Stock		Order Number	Dimensions (mm)				Type
		VP15TF			L1	L3	L9	D4	
6.3	12	●		MPS0630-L12C	139	99	36	8	A
	15	●		MPS0630-L15C	158	118	36	8	A
	20	□		MPS0630-L20C	191	151	36	8	A
	25	□		MPS0630-L25C	223	183	36	8	A
	30	□		MPS0630-L30C	256	216	36	8	A
	20	●		MSL0630-L20C	191	151	36	8	B
	25	●		MSL0630-L25C	223	183	36	8	B
	30	●		MSL0630-L30C	256	216	36	8	B
6.4	3	●		MPS0640S-DIN	79	34	36	8	A
	3	●		MPS0640S-DIN-C	79	34	36	8	A
	5	●		MPS0640L-DIN	91	53	36	8	A
	5	●		MPS0640L-DIN-C	91	53	36	8	A
	8	●		MPS0640-L8C	113	73	36	8	A
	10	□		MPS0640-L10C	126	86	36	8	A
	12	●		MPS0640-L12C	139	99	36	8	A
	15	●		MPS0640-L15C	158	118	36	8	A
	20	□		MPS0640-L20C	191	151	36	8	A
	25	□		MPS0640-L25C	223	183	36	8	A
	30	□		MPS0640-L30C	256	216	36	8	A
		20	●		MSL0640-L20C	191	151	36	8
	25	●		MSL0640-L25C	223	183	36	8	B
	30	●		MSL0640-L30C	256	216	36	8	B
6.5	3	●		MPS0650S-DIN	79	34	36	8	A
	3	●		MPS0650S-DIN-C	79	34	36	8	A
	5	●		MPS0650L-DIN	91	53	36	8	A
	5	●		MPS0650L-DIN-C	91	53	36	8	A
	8	●		MPS0650-L8C	113	73	36	8	A
	10	□		MPS0650-L10C	126	86	36	8	A
	12	●		MPS0650-L12C	139	99	36	8	A
	15	●		MPS0650-L15C	158	118	36	8	A
	20	□		MPS0650-L20C	191	151	36	8	A
	25	□		MPS0650-L25C	223	183	36	8	A
	30	□		MPS0650-L30C	256	216	36	8	A
		20	●		MSL0650-L20C	191	151	36	8
	25	●		MSL0650-L25C	223	183	36	8	B
	30	●		MSL0650-L30C	256	216	36	8	B
6.6	3	●		MPS0660S-DIN	79	34	36	8	A
	3	●		MPS0660S-DIN-C	79	34	36	8	A
	5	●		MPS0660L-DIN	91	53	36	8	A
	5	●		MPS0660L-DIN-C	91	53	36	8	A
	8	●		MPS0660-L8C	118	78	36	8	A
	10	□		MPS0660-L10C	132	92	36	8	A
	12	●		MPS0660-L12C	146	106	36	8	A
	15	●		MPS0660-L15C	167	127	36	8	A
	20	□		MPS0660-L20C	202	162	36	8	A
	25	□		MPS0660-L25C	237	197	36	8	A
	30	□		MPS0660-L30C	272	232	36	8	A
		20	●		MSL0660-L20C	202	162	36	8
	25	●		MSL0660-L25C	237	197	36	8	B
	30	●		MSL0660-L30C	272	232	36	8	B





D1 Tolerance	3.0 ≤ D1 ≤ 6.0	6.0 < D1 ≤ 10.0	10.0 < D1 ≤ 18.0	18.0 < D1 ≤ 20.0
DIN type	0.010 -0.002	0.010 -0.005	0.005 -0.013	0.005 -0.016
Others	0 -0.012	0 -0.015	0 -0.018	0 -0.021

\* MPS-DIN type see table above. Other MPS/MSL drills h7 tolerance.

### ● Type A Double margin type

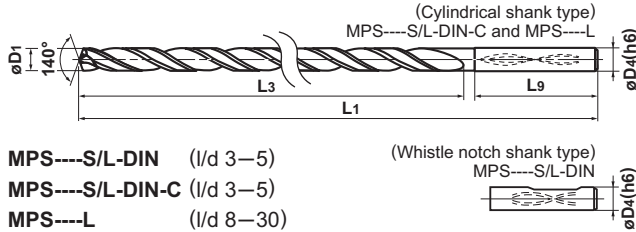

MPS---S/L-DIN (l/d 3-5)

MPS---S/L-DIN-C (l/d 3-5)

MPS---L (l/d 8-30)

### ● Type B Standard margin type



MSL (l/d 20-30)

Drill Dia. D1 (mm)	Hole Depth (l/d)	Stock VP15TF	Order Number	Dimensions (mm)				Type
				L1	L3	L9	D4	
6.7	3	●	MPS0670S-DIN	79	34	36	8	A
	3	●	MPS0670S-DIN-C	79	34	36	8	A
	5	●	MPS0670L-DIN	91	53	36	8	A
	5	●	MPS0670L-DIN-C	91	53	36	8	A
	8	●	MPS0670-L8C	118	78	36	8	A
	10	□	MPS0670-L10C	132	92	36	8	A
	12	●	MPS0670-L12C	146	106	36	8	A
	15	●	MPS0670-L15C	167	127	36	8	A
	20	□	MPS0670-L20C	202	162	36	8	A
	25	□	MPS0670-L25C	237	197	36	8	A
	30	□	MPS0670-L30C	272	232	36	8	A
	20	●	MSL0670-L20C	202	162	36	8	B
25	●	MSL0670-L25C	237	197	36	8	B	
30	●	MSL0670-L30C	272	232	36	8	B	
6.8	3	●	MPS0680S-DIN	79	34	36	8	A
	3	●	MPS0680S-DIN-C	79	34	36	8	A
	5	●	MPS0680L-DIN	91	53	36	8	A
	5	●	MPS0680L-DIN-C	91	53	36	8	A
	8	●	MPS0680-L8C	118	78	36	8	A
	10	□	MPS0680-L10C	132	92	36	8	A
	12	●	MPS0680-L12C	146	106	36	8	A
	15	●	MPS0680-L15C	167	127	36	8	A
	20	□	MPS0680-L20C	202	162	36	8	A
	25	□	MPS0680-L25C	237	197	36	8	A
	30	□	MPS0680-L30C	272	232	36	8	A
	20	●	MSL0680-L20C	202	162	36	8	B
25	●	MSL0680-L25C	237	197	36	8	B	
30	●	MSL0680-L30C	272	232	36	8	B	
6.9	3	●	MPS0690S-DIN	79	34	36	8	A
	3	●	MPS0690S-DIN-C	79	34	36	8	A
	5	●	MPS0690L-DIN	91	53	36	8	A
	5	●	MPS0690L-DIN-C	91	53	36	8	A
	8	●	MPS0690-L8C	118	78	36	8	A
	10	□	MPS0690-L10C	132	92	36	8	A
	12	●	MPS0690-L12C	146	106	36	8	A
	15	●	MPS0690-L15C	167	127	36	8	A
	20	□	MPS0690-L20C	202	162	36	8	A
	25	□	MPS0690-L25C	237	197	36	8	A
	30	□	MPS0690-L30C	272	232	36	8	A
	20	●	MSL0690-L20C	202	162	36	8	B
25	●	MSL0690-L25C	237	197	36	8	B	
30	●	MSL0690-L30C	272	232	36	8	B	

Drill Dia. D1 (mm)	Hole Depth (l/d)	Stock VP15TF	Order Number	Dimensions (mm)				Type
				L1	L3	L9	D4	
7.0	3	●	MPS0700S-DIN	79	34	36	8	A
	3	●	MPS0700S-DIN-C	79	34	36	8	A
	5	●	MPS0700L-DIN	91	53	36	8	A
	5	●	MPS0700L-DIN-C	91	53	36	8	A
	8	●	MPS0700-L8C	118	78	36	8	A
	10	□	MPS0700-L10C	132	92	36	8	A
	12	●	MPS0700-L12C	146	106	36	8	A
	15	●	MPS0700-L15C	167	127	36	8	A
	20	□	MPS0700-L20C	202	162	36	8	A
	25	□	MPS0700-L25C	237	197	36	8	A
	30	□	MPS0700-L30C	272	232	36	8	A
	20	●	MSL0700-L20C	202	162	36	8	B
25	●	MSL0700-L25C	237	197	36	8	B	
30	●	MSL0700-L30C	272	232	36	8	B	
7.1	3	●	MPS0710S-DIN	79	41	36	8	A
	3	●	MPS0710S-DIN-C	79	41	36	8	A
	5	●	MPS0710L-DIN	91	53	36	8	A
	5	●	MPS0710L-DIN-C	91	53	36	8	A
	8	●	MPS0710-L8C	124	84	36	8	A
	10	□	MPS0710-L10C	139	99	36	8	A
	12	●	MPS0710-L12C	154	114	36	8	A
	15	●	MPS0710-L15C	176	136	36	8	A
	20	□	MPS0710-L20C	214	174	36	8	A
	25	□	MPS0710-L25C	251	211	36	8	A
	30	□	MPS0710-L30C	289	249	36	8	A
	20	●	MSL0710-L20C	214	174	36	8	B
25	●	MSL0710-L25C	251	211	36	8	B	
30	●	MSL0710-L30C	289	249	36	8	B	
7.2	3	●	MPS0720S-DIN	79	41	36	8	A
	3	●	MPS0720S-DIN-C	79	41	36	8	A
	5	●	MPS0720L-DIN	91	53	36	8	A
	5	●	MPS0720L-DIN-C	91	53	36	8	A
	8	●	MPS0720-L8C	124	84	36	8	A
	10	□	MPS0720-L10C	139	99	36	8	A
	12	●	MPS0720-L12C	154	114	36	8	A
	15	●	MPS0720-L15C	176	136	36	8	A
	20	□	MPS0720-L20C	214	174	36	8	A
	25	□	MPS0720-L25C	251	211	36	8	A
	30	□	MPS0720-L30C	289	249	36	8	A
	20	●	MSL0720-L20C	214	174	36	8	B
25	●	MSL0720-L25C	251	211	36	8	B	
30	●	MSL0720-L30C	289	249	36	8	B	

Drill Dia. D1 (mm)	Hole Depth (l/d)	Stock		Order Number	Dimensions (mm)				Type
		VP15TF			L1	L3	L9	D4	
7.3	3	●		MPS0730S-DIN	79	41	36	8	A
	3	●		MPS0730S-DIN-C	79	41	36	8	A
	5	●		MPS0730L-DIN	91	53	36	8	A
	5	●		MPS0730L-DIN-C	91	53	36	8	A
	8	●		MPS0730-L8C	124	84	36	8	A
	10	□		MPS0730-L10C	139	99	36	8	A
	12	●		MPS0730-L12C	154	114	36	8	A
	15	●		MPS0730-L15C	176	136	36	8	A
	20	□		MPS0730-L20C	214	174	36	8	A
	25	□		MPS0730-L25C	251	211	36	8	A
	30	□		MPS0730-L30C	289	249	36	8	A
	20	●		MSL0730-L20C	214	174	36	8	B
	25	●		MSL0730-L25C	251	211	36	8	B
	30	●		MSL0730-L30C	289	249	36	8	B
7.4	3	●		MPS0740S-DIN	79	41	36	8	A
	3	●		MPS0740S-DIN-C	79	41	36	8	A
	5	●		MPS0740L-DIN	91	53	36	8	A
	5	●		MPS0740L-DIN-C	91	53	36	8	A
	8	●		MPS0740-L8C	124	84	36	8	A
	10	□		MPS0740-L10C	139	99	36	8	A
	12	●		MPS0740-L12C	154	114	36	8	A
	15	●		MPS0740-L15C	176	136	36	8	A
	20	□		MPS0740-L20C	214	174	36	8	A
	25	□		MPS0740-L25C	251	211	36	8	A
	30	□		MPS0740-L30C	289	249	36	8	A
	20	●		MSL0740-L20C	214	174	36	8	B
	25	●		MSL0740-L25C	251	211	36	8	B
	30	●		MSL0740-L30C	289	249	36	8	B
7.5	3	●		MPS0750S-DIN	79	41	36	8	A
	3	●		MPS0750S-DIN-C	79	41	36	8	A
	5	●		MPS0750L-DIN	91	53	36	8	A
	5	●		MPS0750L-DIN-C	91	53	36	8	A
	8	●		MPS0750-L8C	124	84	36	8	A
	10	□		MPS0750-L10C	139	99	36	8	A
	12	●		MPS0750-L12C	154	114	36	8	A
	15	●		MPS0750-L15C	176	136	36	8	A
	20	□		MPS0750-L20C	214	174	36	8	A
	25	□		MPS0750-L25C	251	211	36	8	A
	30	□		MPS0750-L30C	289	249	36	8	A
	20	●		MSL0750-L20C	214	174	36	8	B
	25	●		MSL0750-L25C	251	211	36	8	B
	30	●		MSL0750-L30C	289	249	36	8	B
7.6	3	●		MPS0760S-DIN	79	41	36	8	A
	3	●		MPS0760S-DIN-C	79	41	36	8	A
	5	●		MPS0760L-DIN	91	53	36	8	A
	5	●		MPS0760L-DIN-C	91	53	36	8	A
	8	●		MPS0760-L8C	129	89	36	8	A
	10	□		MPS0760-L10C	145	105	36	8	A
	12	●		MPS0760-L12C	161	121	36	8	A
	15	●		MPS0760-L15C	185	145	36	8	A
	20	□		MPS0760-L20C	225	185	36	8	A
	25	□		MPS0760-L25C	265	225	36	8	A
	30	□		MPS0760-L30C	305	265	36	8	A
	20	●		MSL0760-L20C	225	185	36	8	B

Drill Dia. D1 (mm)	Hole Depth (l/d)	Stock		Order Number	Dimensions (mm)				Type
		VP15TF			L1	L3	L9	D4	
7.6	25	●		MSL0760-L25C	265	225	36	8	B
	30	●		MSL0760-L30C	305	265	36	8	B
7.7	3	●		MPS0770S-DIN	79	41	36	8	A
	3	●		MPS0770S-DIN-C	79	41	36	8	A
	5	●		MPS0770L-DIN	91	53	36	8	A
	5	●		MPS0770L-DIN-C	91	53	36	8	A
	8	●		MPS0770-L8C	129	89	36	8	A
	10	□		MPS0770-L10C	145	105	36	8	A
	12	●		MPS0770-L12C	161	121	36	8	A
	15	●		MPS0770-L15C	185	145	36	8	A
	20	□		MPS0770-L20C	225	185	36	8	A
	25	□		MPS0770-L25C	265	225	36	8	A
	30	□		MPS0770-L30C	305	265	36	8	A
	20	●		MSL0770-L20C	225	185	36	8	B
	25	●		MSL0770-L25C	265	225	36	8	B
	30	●		MSL0770-L30C	305	265	36	8	B
7.8	3	●		MPS0780S-DIN	79	41	36	8	A
	3	●		MPS0780S-DIN-C	79	41	36	8	A
	5	●		MPS0780L-DIN	91	53	36	8	A
	5	●		MPS0780L-DIN-C	91	53	36	8	A
	8	●		MPS0780-L8C	129	89	36	8	A
	10	□		MPS0780-L10C	145	105	36	8	A
	12	●		MPS0780-L12C	161	121	36	8	A
	15	●		MPS0780-L15C	185	145	36	8	A
	20	□		MPS0780-L20C	225	185	36	8	A
	25	□		MPS0780-L25C	265	225	36	8	A
	30	□		MPS0780-L30C	305	265	36	8	A
	20	●		MSL0780-L20C	225	185	36	8	B
	25	●		MSL0780-L25C	265	225	36	8	B
	30	●		MSL0780-L30C	305	265	36	8	B
7.9	3	●		MPS0790S-DIN	79	41	36	8	A
	3	●		MPS0790S-DIN-C	79	41	36	8	A
	5	●		MPS0790L-DIN	91	53	36	8	A
	5	●		MPS0790L-DIN-C	91	53	36	8	A
	8	●		MPS0790-L8C	129	89	36	8	A
	10	□		MPS0790-L10C	145	105	36	8	A
	12	●		MPS0790-L12C	161	121	36	8	A
	15	●		MPS0790-L15C	185	145	36	8	A
	20	□		MPS0790-L20C	225	185	36	8	A
	25	□		MPS0790-L25C	265	225	36	8	A
	30	□		MPS0790-L30C	305	265	36	8	A
	20	●		MSL0790-L20C	225	185	36	8	B
	25	●		MSL0790-L25C	265	225	36	8	B
	30	●		MSL0790-L30C	305	265	36	8	B

# Solid Carbide Drill

## MPS/MSL



D1 Tolerance	3.0 ≤ D1 ≤ 6.0	6.0 < D1 ≤ 10.0	10.0 < D1 ≤ 18.0	18.0 < D1 ≤ 20.0
DIN type	0.010 -0.002	0.010 -0.005	0.005 -0.013	0.005 -0.016
Others	0 -0.012	0 -0.015	0 -0.018	0 -0.021

\* MPS-DIN type see table above. Other MPS/MSL drills h7 tolerance.

### ● Type A Double margin type

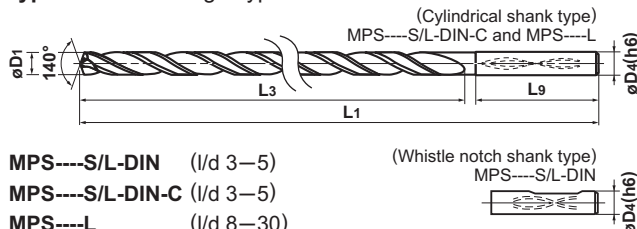

MPS---S/L-DIN (l/d 3-5)

MPS---S/L-DIN-C (l/d 3-5)

MPS---L (l/d 8-30)

### ● Type B Standard margin type



MSL (l/d 20-30)

Drill Dia. D1 (mm)	Hole Depth (l/d)	Stock VP15TF	Order Number	Dimensions (mm)				Type
				L1	L3	L9	D4	
8.0	3	●	MPS0800S-DIN	79	41	36	8	A
	3	●	MPS0800S-DIN-C	79	41	36	8	A
	5	●	MPS0800L-DIN	91	53	36	8	A
	5	●	MPS0800L-DIN-C	91	53	36	8	A
	8	●	MPS0800-L8C	129	89	36	8	A
	10	□	MPS0800-L10C	145	105	36	8	A
	12	●	MPS0800-L12C	161	121	36	8	A
	15	●	MPS0800-L15C	185	145	36	8	A
	20	□	MPS0800-L20C	225	185	36	8	A
	25	□	MPS0800-L25C	265	225	36	8	A
	30	□	MPS0800-L30C	305	265	36	8	A
	20	●	MSL0800-L20C	225	185	36	8	B
25	●	MSL0800-L25C	265	225	36	8	B	
30	●	MSL0800-L30C	305	265	36	8	B	
NEW 8.05	3	●	MPS0805S-DIN	88	46	40	10	A
	3	●	MPS0805S-DIN-C	88	46	40	10	A
	5	●	MPS0805L-DIN	102	60	40	10	A
	5	●	MPS0805L-DIN-C	102	60	40	10	A
8.1	3	●	MPS0810S-DIN	88	46	40	10	A
	3	●	MPS0810S-DIN-C	88	46	40	10	A
	5	●	MPS0810L-DIN	102	60	40	10	A
	5	●	MPS0810L-DIN-C	102	60	40	10	A
	8	●	MPS0810-L8C	139	95	40	10	A
	10	□	MPS0810-L10C	156	112	40	10	A
	12	●	MPS0810-L12C	173	129	40	10	A
	15	●	MPS0810-L15C	198	154	40	10	A
	20	□	MPS0810-L20C	241	197	40	10	A
	25	□	MPS0810-L25C	283	239	40	10	A
	NEW 30	□	MPS0810-L30C	326	282	40	10	A
	20	●	MSL0810-L20C	241	197	40	10	B
25	●	MSL0810-L25C	283	239	40	10	B	
NEW 30	□	MSL0810-L30C	326	282	40	10	B	
8.2	3	●	MPS0820S-DIN	88	46	40	10	A
	3	●	MPS0820S-DIN-C	88	46	40	10	A
	5	●	MPS0820L-DIN	102	60	40	10	A
	5	●	MPS0820L-DIN-C	102	60	40	10	A
	8	●	MPS0820-L8C	139	95	40	10	A
	10	□	MPS0820-L10C	156	112	40	10	A
	12	●	MPS0820-L12C	173	129	40	10	A
	15	●	MPS0820-L15C	198	154	40	10	A
	20	□	MPS0820-L20C	241	197	40	10	A
	25	□	MPS0820-L25C	283	239	40	10	A

Drill Dia. D1 (mm)	Hole Depth (l/d)	Stock VP15TF	Order Number	Dimensions (mm)				Type
				L1	L3	L9	D4	
NEW 8.2	30	□	MPS0820-L30C	326	282	40	10	A
	20	●	MSL0820-L20C	241	197	40	10	B
	25	●	MSL0820-L25C	283	239	40	10	B
	NEW 30	□	MSL0820-L30C	326	282	40	10	B
8.3	3	●	MPS0830S-DIN	88	46	40	10	A
	3	●	MPS0830S-DIN-C	88	46	40	10	A
	5	●	MPS0830L-DIN	102	60	40	10	A
	5	●	MPS0830L-DIN-C	102	60	40	10	A
	8	●	MPS0830-L8C	139	95	40	10	A
	10	□	MPS0830-L10C	156	112	40	10	A
	12	●	MPS0830-L12C	173	129	40	10	A
	15	●	MPS0830-L15C	198	154	40	10	A
	20	□	MPS0830-L20C	241	197	40	10	A
	25	□	MPS0830-L25C	283	239	40	10	A
	NEW 30	□	MPS0830-L30C	326	282	40	10	A
	20	●	MSL0830-L20C	241	197	40	10	B
25	●	MSL0830-L25C	283	239	40	10	B	
NEW 30	□	MSL0830-L30C	326	282	40	10	B	
8.4	3	●	MPS0840S-DIN	88	46	40	10	A
	3	●	MPS0840S-DIN-C	88	46	40	10	A
	5	●	MPS0840L-DIN	102	60	40	10	A
	5	●	MPS0840L-DIN-C	102	60	40	10	A
	8	●	MPS0840-L8C	139	95	40	10	A
	10	□	MPS0840-L10C	156	112	40	10	A
	12	●	MPS0840-L12C	173	129	40	10	A
	15	●	MPS0840-L15C	198	154	40	10	A
	20	□	MPS0840-L20C	241	197	40	10	A
	25	□	MPS0840-L25C	283	239	40	10	A
	NEW 30	□	MPS0840-L30C	326	282	40	10	A
	20	●	MSL0840-L20C	241	197	40	10	B
25	●	MSL0840-L25C	283	239	40	10	B	
NEW 30	□	MSL0840-L30C	326	282	40	10	B	
8.5	3	●	MPS0850S-DIN	88	46	40	10	A
	3	●	MPS0850S-DIN-C	88	46	40	10	A
	5	●	MPS0850L-DIN	102	60	40	10	A
	5	●	MPS0850L-DIN-C	102	60	40	10	A
	8	●	MPS0850-L8C	139	95	40	10	A
	10	□	MPS0850-L10C	156	112	40	10	A
	12	●	MPS0850-L12C	173	129	40	10	A
	15	●	MPS0850-L15C	198	154	40	10	A
	20	□	MPS0850-L20C	241	197	40	10	A
	25	□	MPS0850-L25C	283	239	40	10	A

● : Inventory maintained. □ : Non stock, produced to order only.



Drill Dia. D1 (mm)	Hole Depth (l/d)	Stock		Order Number	Dimensions (mm)				Type
		VP15TF			L1	L3	L9	D4	
8.5	30	NEW	□	MPS0850-L30C	326	282	40	10	A
	20	●		MSL0850-L20C	241	197	40	10	B
	25	●		MSL0850-L25C	283	239	40	10	B
	30	NEW	●	MSL0850-L30C	326	282	40	10	B
8.6	3	●		MPS0860S-DIN	88	46	40	10	A
	3	●		MPS0860S-DIN-C	88	46	40	10	A
	5	●		MPS0860L-DIN	102	60	40	10	A
	5	●		MPS0860L-DIN-C	102	60	40	10	A
	8	●		MPS0860-L8C	144	100	40	10	A
	10	□		MPS0860-L10C	162	118	40	10	A
	12	●		MPS0860-L12C	180	136	40	10	A
	15	●		MPS0860-L15C	207	163	40	10	A
	20	□		MPS0860-L20C	252	208	40	10	A
	25	□		MPS0860-L25C	297	253	40	10	A
	30	NEW	□	MPS0860-L30C	342	298	40	10	A
	20	●		MSL0860-L20C	252	208	40	10	B
25	●		MSL0860-L25C	297	253	40	10	B	
30	NEW	□	MSL0860-L30C	342	298	40	10	B	
8.7	3	●		MPS0870S-DIN	88	46	40	10	A
	3	●		MPS0870S-DIN-C	88	46	40	10	A
	5	●		MPS0870L-DIN	102	60	40	10	A
	5	●		MPS0870L-DIN-C	102	60	40	10	A
	8	●		MPS0870-L8C	144	100	40	10	A
	10	□		MPS0870-L10C	162	118	40	10	A
	12	●		MPS0870-L12C	180	136	40	10	A
	15	●		MPS0870-L15C	207	163	40	10	A
	20	□		MPS0870-L20C	252	208	40	10	A
	25	□		MPS0870-L25C	297	253	40	10	A
	30	NEW	□	MPS0870-L30C	342	298	40	10	A
	20	●		MSL0870-L20C	252	208	40	10	B
25	●		MSL0870-L25C	297	253	40	10	B	
30	NEW	□	MSL0870-L30C	342	298	40	10	B	
8.8	3	●		MPS0880S-DIN	88	46	40	10	A
	3	●		MPS0880S-DIN-C	88	46	40	10	A
	5	●		MPS0880L-DIN	102	60	40	10	A
	5	●		MPS0880L-DIN-C	102	60	40	10	A
	8	●		MPS0880-L8C	144	100	40	10	A
	10	□		MPS0880-L10C	162	118	40	10	A
	12	●		MPS0880-L12C	180	136	40	10	A
	15	●		MPS0880-L15C	207	163	40	10	A
	20	□		MPS0880-L20C	252	208	40	10	A
	25	□		MPS0880-L25C	297	253	40	10	A
	30	NEW	□	MPS0880-L30C	342	298	40	10	A
	20	●		MSL0880-L20C	252	208	40	10	B
25	●		MSL0880-L25C	297	253	40	10	B	
30	NEW	●	MSL0880-L30C	342	298	40	10	B	
8.9	3	●		MPS0890S-DIN	88	46	40	10	A
	3	●		MPS0890S-DIN-C	88	46	40	10	A
	5	●		MPS0890L-DIN	102	60	40	10	A
	5	●		MPS0890L-DIN-C	102	60	40	10	A
	8	●		MPS0890-L8C	144	100	40	10	A
	10	□		MPS0890-L10C	162	118	40	10	A
	12	●		MPS0890-L12C	180	136	40	10	A
	15	●		MPS0890-L15C	207	163	40	10	A
	20	□		MPS0890-L20C	252	208	40	10	A
25	□		MPS0890-L25C	297	253	40	10	A	

Drill Dia. D1 (mm)	Hole Depth (l/d)	Stock		Order Number	Dimensions (mm)				Type
		VP15TF			L1	L3	L9	D4	
8.9	30	NEW	□	MPS0890-L30C	342	298	40	10	A
	20	●		MSL0890-L20C	252	208	40	10	B
	25	●		MSL0890-L25C	297	253	40	10	B
	30	NEW	□	MSL0890-L30C	342	298	40	10	B
9.0	3	●		MPS0900S-DIN	88	46	40	10	A
	3	●		MPS0900S-DIN-C	88	46	40	10	A
	5	●		MPS0900L-DIN	102	60	40	10	A
	5	●		MPS0900L-DIN-C	102	60	40	10	A
	8	●		MPS0900-L8C	144	100	40	10	A
	10	□		MPS0900-L10C	162	118	40	10	A
	12	●		MPS0900-L12C	180	136	40	10	A
	15	●		MPS0900-L15C	207	163	40	10	A
	20	□		MPS0900-L20C	252	208	40	10	A
	25	□		MPS0900-L25C	297	253	40	10	A
	30	NEW	□	MPS0900-L30C	342	298	40	10	A
	20	●		MSL0900-L20C	252	208	40	10	B
25	●		MSL0900-L25C	297	253	40	10	B	
30	NEW	●	MSL0900-L30C	342	298	40	10	B	
9.1	3	●		MPS0910S-DIN	89	47	40	10	A
	3	●		MPS0910S-DIN-C	89	47	40	10	A
	5	●		MPS0910L-DIN	103	62	40	10	A
	5	●		MPS0910L-DIN-C	103	62	40	10	A
	8	●		MPS0910-L8C	151	107	40	10	A
	10	□		MPS0910-L10C	170	126	40	10	A
	12	●		MPS0910-L12C	189	145	40	10	A
	15	●		MPS0910-L15C	217	173	40	10	A
	20	□		MPS0910-L20C	265	221	40	10	A
	25	NEW	□	MPS0910-L25C	312	268	40	10	A
	30	NEW	□	MPS0910-L30C	360	316	40	10	A
	20	●		MSL0910-L20C	265	221	40	10	B
25	NEW	□	MSL0910-L25C	312	268	40	10	B	
30	NEW	□	MSL0910-L30C	360	316	40	10	B	
9.2	3	●		MPS0920S-DIN	89	47	40	10	A
	3	●		MPS0920S-DIN-C	89	47	40	10	A
	5	●		MPS0920L-DIN	103	62	40	10	A
	5	●		MPS0920L-DIN-C	103	62	40	10	A
	8	●		MPS0920-L8C	151	107	40	10	A
	10	□		MPS0920-L10C	170	126	40	10	A
	12	●		MPS0920-L12C	189	145	40	10	A
	15	●		MPS0920-L15C	217	173	40	10	A
	20	□		MPS0920-L20C	265	221	40	10	A
	25	NEW	□	MPS0920-L25C	312	268	40	10	A
	30	NEW	□	MPS0920-L30C	360	316	40	10	A
	20	●		MSL0920-L20C	265	221	40	10	B
25	NEW	□	MSL0920-L25C	312	268	40	10	B	
30	NEW	□	MSL0920-L30C	360	316	40	10	B	



D1 Tolerance	3.0 ≤ D1 ≤ 6.0	6.0 < D1 ≤ 10.0	10.0 < D1 ≤ 18.0	18.0 < D1 ≤ 20.0
DIN type	0.010 -0.002	0.010 -0.005	0.005 -0.013	0.005 -0.016
Others	0 -0.012	0 -0.015	0 -0.018	0 -0.021

\* MPS-DIN type see table above. Other MPS/MSL drills h7 tolerance.

### ● Type A Double margin type

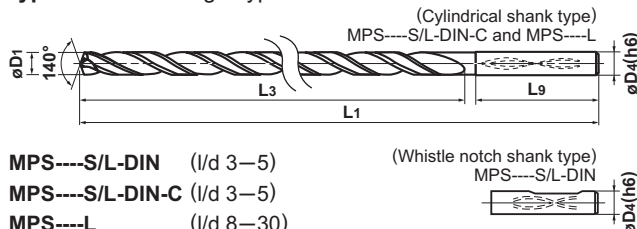

MPS---S/L-DIN (l/d 3-5)

MPS---S/L-DIN-C (l/d 3-5)

MPS---L (l/d 8-30)

### ● Type B Standard margin type



MSL (l/d 20-30)

Drill Dia. D1 (mm)	Hole Depth (l/d)	Stock VP15TF	Order Number	Dimensions (mm)				Type
				L1	L3	L9	D4	
9.3	3	●	MPS0930S-DIN	89	47	40	10	A
	3	●	MPS0930S-DIN-C	89	47	40	10	A
	5	●	MPS0930L-DIN	103	62	40	10	A
	5	●	MPS0930L-DIN-C	103	62	40	10	A
	8	●	MPS0930-L8C	151	107	40	10	A
	10	□	MPS0930-L10C	170	126	40	10	A
	12	●	MPS0930-L12C	189	145	40	10	A
	15	●	MPS0930-L15C	217	173	40	10	A
	20	□	MPS0930-L20C	265	221	40	10	A
	NEW 25	□	MPS0930-L25C	312	268	40	10	A
	NEW 30	□	MPS0930-L30C	360	316	40	10	A
	20	●	MSL0930-L20C	265	221	40	10	B
NEW 25	□	MSL0930-L25C	312	268	40	10	B	
NEW 30	□	MSL0930-L30C	360	316	40	10	B	
9.4	3	●	MPS0940S-DIN	89	47	40	10	A
	3	●	MPS0940S-DIN-C	89	47	40	10	A
	5	●	MPS0940L-DIN	103	62	40	10	A
	5	●	MPS0940L-DIN-C	103	62	40	10	A
	8	●	MPS0940-L8C	151	107	40	10	A
	10	□	MPS0940-L10C	170	126	40	10	A
	12	●	MPS0940-L12C	189	145	40	10	A
	15	●	MPS0940-L15C	217	173	40	10	A
	20	□	MPS0940-L20C	265	221	40	10	A
	NEW 25	□	MPS0940-L25C	312	268	40	10	A
	NEW 30	□	MPS0940-L30C	360	316	40	10	A
	20	●	MSL0940-L20C	265	221	40	10	B
NEW 25	□	MSL0940-L25C	312	268	40	10	B	
NEW 30	□	MSL0940-L30C	360	316	40	10	B	
9.5	3	●	MPS0950S-DIN	89	47	40	10	A
	3	●	MPS0950S-DIN-C	89	47	40	10	A
	5	●	MPS0950L-DIN	103	62	40	10	A
	5	●	MPS0950L-DIN-C	103	62	40	10	A
	8	●	MPS0950-L8C	151	107	40	10	A
	10	□	MPS0950-L10C	170	126	40	10	A
	12	●	MPS0950-L12C	189	145	40	10	A
	15	●	MPS0950-L15C	217	173	40	10	A
	20	□	MPS0950-L20C	265	221	40	10	A
	NEW 25	□	MPS0950-L25C	312	268	40	10	A
	NEW 30	□	MPS0950-L30C	360	316	40	10	A
	20	●	MSL0950-L20C	265	221	40	10	B
NEW 25	●	MSL0950-L25C	312	268	40	10	B	
NEW 30	●	MSL0950-L30C	360	316	40	10	B	

Drill Dia. D1 (mm)	Hole Depth (l/d)	Stock VP15TF	Order Number	Dimensions (mm)				Type
				L1	L3	L9	D4	
9.6	3	●	MPS0960S-DIN	89	47	40	10	A
	3	●	MPS0960S-DIN-C	89	47	40	10	A
	5	●	MPS0960L-DIN	103	62	40	10	A
	5	●	MPS0960L-DIN-C	103	62	40	10	A
	8	●	MPS0960-L8C	156	112	40	10	A
	10	□	MPS0960-L10C	176	132	40	10	A
	12	●	MPS0960-L12C	196	152	40	10	A
	15	●	MPS0960-L15C	226	182	40	10	A
	20	□	MPS0960-L20C	276	232	40	10	A
	NEW 25	□	MPS0960-L25C	326	282	40	10	A
	NEW 30	□	MPS0960-L30C	376	332	40	10	A
	20	●	MSL0960-L20C	276	232	40	10	B
NEW 25	□	MSL0960-L25C	326	282	40	10	B	
NEW 30	□	MSL0960-L30C	376	332	40	10	B	
9.7	3	●	MPS0970S-DIN	89	47	40	10	A
	3	●	MPS0970S-DIN-C	89	47	40	10	A
	5	●	MPS0970L-DIN	103	62	40	10	A
	5	●	MPS0970L-DIN-C	103	62	40	10	A
	8	●	MPS0970-L8C	156	112	40	10	A
	10	□	MPS0970-L10C	176	132	40	10	A
	12	●	MPS0970-L12C	196	152	40	10	A
	15	●	MPS0970-L15C	226	182	40	10	A
	20	□	MPS0970-L20C	276	232	40	10	A
	NEW 25	□	MPS0970-L25C	326	282	40	10	A
	NEW 30	□	MPS0970-L30C	376	332	40	10	A
	20	●	MSL0970-L20C	276	232	40	10	B
NEW 25	□	MSL0970-L25C	326	282	40	10	B	
NEW 30	□	MSL0970-L30C	376	332	40	10	B	
9.8	3	●	MPS0980S-DIN	89	47	40	10	A
	3	●	MPS0980S-DIN-C	89	47	40	10	A
	5	●	MPS0980L-DIN	103	62	40	10	A
	5	●	MPS0980L-DIN-C	103	62	40	10	A
	8	●	MPS0980-L8C	156	112	40	10	A
	10	□	MPS0980-L10C	176	132	40	10	A
	12	●	MPS0980-L12C	196	152	40	10	A
	15	●	MPS0980-L15C	226	182	40	10	A
	20	□	MPS0980-L20C	276	232	40	10	A
	NEW 25	□	MPS0980-L25C	326	282	40	10	A
	NEW 30	□	MPS0980-L30C	376	332	40	10	A
	20	●	MSL0980-L20C	276	232	40	10	B
NEW 25	□	MSL0980-L25C	326	282	40	10	B	
NEW 30	□	MSL0980-L30C	376	332	40	10	B	

Drill Dia. D1 (mm)	Hole Depth (l/d)	Stock		Order Number	Dimensions (mm)				Type
		VP15TF			L1	L3	L9	D4	
9.9	3	●		MPS0990S-DIN	89	47	40	10	A
	3	●		MPS0990S-DIN-C	89	47	40	10	A
	5	●		MPS0990L-DIN	103	62	40	10	A
	5	●		MPS0990L-DIN-C	103	62	40	10	A
	8	●		MPS0990-L8C	156	112	40	10	A
	10	□		MPS0990-L10C	176	132	40	10	A
	12	●		MPS0990-L12C	196	152	40	10	A
	15	●		MPS0990-L15C	226	182	40	10	A
	20	□		MPS0990-L20C	276	232	40	10	A
	NEW 25	□		MPS0990-L25C	326	282	40	10	A
	NEW 30	□		MPS0990-L30C	376	332	40	10	A
	NEW 20	●		MSL0990-L20C	276	232	40	10	B
NEW 25	□		MSL0990-L25C	326	282	40	10	B	
NEW 30	□		MSL0990-L30C	376	332	40	10	B	
10.0	3	●		MPS1000S-DIN	89	47	40	10	A
	3	●		MPS1000S-DIN-C	89	47	40	10	A
	5	●		MPS1000L-DIN	103	62	40	10	A
	5	●		MPS1000L-DIN-C	103	62	40	10	A
	8	●		MPS1000-L8C	156	112	40	10	A
	10	□		MPS1000-L10C	176	132	40	10	A
	12	●		MPS1000-L12C	196	152	40	10	A
	15	●		MPS1000-L15C	226	182	40	10	A
	20	□		MPS1000-L20C	276	232	40	10	A
	NEW 25	□		MPS1000-L25C	326	282	40	10	A
	NEW 30	□		MPS1000-L30C	376	332	40	10	A
	NEW 20	●		MSL1000-L20C	276	232	40	10	B
	NEW 25	●		MSL1000-L25C	326	282	40	10	B
	NEW 30	●		MSL1000-L30C	376	332	40	10	B
	10.05	3	●		MPS1005S-DIN	102	55	45	12
3		●		MPS1005S-DIN-C	102	55	45	12	A
5		●		MPS1005L-DIN	118	71	45	12	A
5		●		MPS1005L-DIN-C	118	71	45	12	A
10.1	3	●		MPS1010S-DIN	102	55	45	12	A
	3	●		MPS1010S-DIN-C	102	55	45	12	A
	5	●		MPS1010L-DIN	118	71	45	12	A
	5	●		MPS1010L-DIN-C	118	71	45	12	A
	8	●		MPS1010-L8C	167	118	45	12	A
	10	□		MPS1010-L10C	188	139	45	12	A
	12	●		MPS1010-L12C	209	160	45	12	A
	15	●		MPS1010-L15C	240	191	45	12	A
	20	□		MPS1010-L20C	293	244	45	12	A
	NEW 25	□		MPS1010-L25C	345	296	45	12	A
NEW 20	●		MSL1010-L20C	293	244	45	12	B	
NEW 25	□		MSL1010-L25C	345	296	45	12	B	
10.2	3	●		MPS1020S-DIN	102	55	45	12	A
	3	●		MPS1020S-DIN-C	102	55	45	12	A
	5	●		MPS1020L-DIN	118	71	45	12	A
	5	●		MPS1020L-DIN-C	118	71	45	12	A
	8	●		MPS1020-L8C	167	118	45	12	A
	10	□		MPS1020-L10C	188	139	45	12	A
	12	●		MPS1020-L12C	209	160	45	12	A
	15	●		MPS1020-L15C	240	191	45	12	A
	20	□		MPS1020-L20C	293	244	45	12	A
	NEW 25	□		MPS1020-L25C	345	296	45	12	A
NEW 20	●		MSL1020-L20C	293	244	45	12	B	
NEW 25	□		MSL1020-L25C	345	296	45	12	B	

Drill Dia. D1 (mm)	Hole Depth (l/d)	Stock		Order Number	Dimensions (mm)				Type
		VP15TF			L1	L3	L9	D4	
10.3	3	●		MPS1030S-DIN	102	55	45	12	A
	3	●		MPS1030S-DIN-C	102	55	45	12	A
	5	●		MPS1030L-DIN	118	71	45	12	A
	5	●		MPS1030L-DIN-C	118	71	45	12	A
	8	●		MPS1030-L8C	167	118	45	12	A
	10	□		MPS1030-L10C	188	139	45	12	A
	12	●		MPS1030-L12C	209	160	45	12	A
	15	●		MPS1030-L15C	240	191	45	12	A
	20	□		MPS1030-L20C	293	244	45	12	A
	NEW 25	□		MPS1030-L25C	345	296	45	12	A
	NEW 20	●		MSL1030-L20C	293	244	45	12	B
	NEW 25	□		MSL1030-L25C	345	296	45	12	B
10.4	3	●		MPS1040S-DIN	102	55	45	12	A
	3	●		MPS1040S-DIN-C	102	55	45	12	A
	5	●		MPS1040L-DIN	118	71	45	12	A
	5	●		MPS1040L-DIN-C	118	71	45	12	A
	8	●		MPS1040-L8C	167	118	45	12	A
	10	□		MPS1040-L10C	188	139	45	12	A
	12	●		MPS1040-L12C	209	160	45	12	A
	15	●		MPS1040-L15C	240	191	45	12	A
	20	□		MPS1040-L20C	293	244	45	12	A
	NEW 25	□		MPS1040-L25C	345	296	45	12	A
	NEW 20	●		MSL1040-L20C	293	244	45	12	B
	NEW 25	□		MSL1040-L25C	345	296	45	12	B
10.5	3	●		MPS1050S-DIN	102	55	45	12	A
	3	●		MPS1050S-DIN-C	102	55	45	12	A
	5	●		MPS1050L-DIN	118	71	45	12	A
	5	●		MPS1050L-DIN-C	118	71	45	12	A
	8	●		MPS1050-L8C	167	118	45	12	A
	10	□		MPS1050-L10C	188	139	45	12	A
	12	●		MPS1050-L12C	209	160	45	12	A
	15	●		MPS1050-L15C	240	191	45	12	A
	20	□		MPS1050-L20C	293	244	45	12	A
	NEW 25	□		MPS1050-L25C	345	296	45	12	A
	NEW 20	●		MSL1050-L20C	293	244	45	12	B
	NEW 25	●		MSL1050-L25C	345	296	45	12	B
10.6	3	●		MPS1060S-DIN	102	55	45	12	A
	3	●		MPS1060S-DIN-C	102	55	45	12	A
	5	●		MPS1060L-DIN	118	71	45	12	A
	5	●		MPS1060L-DIN-C	118	71	45	12	A
	8	●		MPS1060-L8C	172	123	45	12	A
	10	□		MPS1060-L10C	194	145	45	12	A
	12	●		MPS1060-L12C	216	167	45	12	A
	15	●		MPS1060-L15C	249	200	45	12	A
	20	□		MPS1060-L20C	304	255	45	12	A
	NEW 25	□		MPS1060-L25C	359	310	45	12	A
	NEW 20	●		MSL1060-L20C	304	255	45	12	B
	NEW 25	□		MSL1060-L25C	359	310	45	12	B



### ● Type A Double margin type

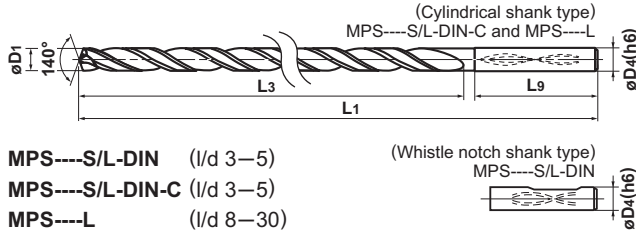

MPS---S/L-DIN (l/d 3-5)

MPS---S/L-DIN-C (l/d 3-5)

MPS---L (l/d 8-30)

D1 Tolerance	3.0 ≤ D1 ≤ 6.0	6.0 < D1 ≤ 10.0	10.0 < D1 ≤ 18.0	18.0 < D1 ≤ 20.0
DIN type	0.010 -0.002	0.010 -0.005	0.005 -0.013	0.005 -0.016
Others	0 -0.012	0 -0.015	0 -0.018	0 -0.021

\* MPS-DIN type see table above. Other MPS/MSL drills h7 tolerance.

Drill Dia. D1 (mm)	Hole Depth (l/d)	Stock VP15TF	Order Number	Dimensions (mm)				Type
				L1	L3	L9	D4	
10.7	3	●	MPS1070S-DIN	102	55	45	12	A
	3	●	MPS1070S-DIN-C	102	55	45	12	A
	5	●	MPS1070L-DIN	118	71	45	12	A
	5	●	MPS1070L-DIN-C	118	71	45	12	A
	8	●	MPS1070-L8C	172	123	45	12	A
	10	□	MPS1070-L10C	194	145	45	12	A
	12	●	MPS1070-L12C	216	167	45	12	A
	15	●	MPS1070-L15C	249	200	45	12	A
	20	□	MPS1070-L20C	304	255	45	12	A
	25	□	MPS1070-L25C	359	310	45	12	A
10.8	3	●	MPS1080S-DIN	102	55	45	12	A
	3	●	MPS1080S-DIN-C	102	55	45	12	A
	5	●	MPS1080L-DIN	118	71	45	12	A
	5	●	MPS1080L-DIN-C	118	71	45	12	A
	8	●	MPS1080-L8C	172	123	45	12	A
	10	□	MPS1080-L10C	194	145	45	12	A
	12	●	MPS1080-L12C	216	167	45	12	A
	15	●	MPS1080-L15C	249	200	45	12	A
	20	□	MPS1080-L20C	304	255	45	12	A
	25	□	MPS1080-L25C	359	310	45	12	A
10.9	3	●	MPS1090S-DIN	102	55	45	12	A
	3	●	MPS1090S-DIN-C	102	55	45	12	A
	5	●	MPS1090L-DIN	118	71	45	12	A
	5	●	MPS1090L-DIN-C	118	71	45	12	A
	8	●	MPS1090-L8C	172	123	45	12	A
	10	□	MPS1090-L10C	194	145	45	12	A
	12	●	MPS1090-L12C	216	167	45	12	A
	15	●	MPS1090-L15C	249	200	45	12	A
	20	□	MPS1090-L20C	304	255	45	12	A
	25	□	MPS1090-L25C	359	310	45	12	A
11.0	3	●	MPS1100S-DIN	102	55	45	12	A
	3	●	MPS1100S-DIN-C	102	55	45	12	A
	5	●	MPS1100L-DIN	118	71	45	12	A
	5	●	MPS1100L-DIN-C	118	71	45	12	A
	8	●	MPS1100-L8C	172	123	45	12	A
	10	□	MPS1100-L10C	194	145	45	12	A
	12	●	MPS1100-L12C	216	167	45	12	A
	15	●	MPS1100-L15C	249	200	45	12	A
	20	□	MPS1100-L20C	304	255	45	12	B
	25	□	MPS1100-L25C	359	310	45	12	B

Drill Dia. D1 (mm)	Hole Depth (l/d)	Stock VP15TF	Order Number	Dimensions (mm)				Type
				L1	L3	L9	D4	
11.0	12	●	MPS1100-L12C	216	167	45	12	A
	15	●	MPS1100-L15C	249	200	45	12	A
	20	□	MPS1100-L20C	304	255	45	12	A
	25	□	MPS1100-L25C	359	310	45	12	A
	20	●	MSL1100-L20C	304	255	45	12	B
	25	●	MSL1100-L25C	359	310	45	12	B
11.1	3	●	MPS1110S-DIN	102	55	45	12	A
	3	●	MPS1110S-DIN-C	102	55	45	12	A
	5	●	MPS1110L-DIN	118	71	45	12	A
	5	●	MPS1110L-DIN-C	118	71	45	12	A
	8	●	MPS1110-L8C	178	129	45	12	A
	10	□	MPS1110-L10C	201	152	45	12	A
	12	●	MPS1110-L12C	224	175	45	12	A
	15	●	MPS1110-L15C	258	209	45	12	A
	20	□	MPS1110-L20C	316	267	45	12	A
	25	□	MPS1110-L25C	373	324	45	12	A
11.2	3	●	MPS1120S-DIN	102	55	45	12	A
	3	●	MPS1120S-DIN-C	102	55	45	12	A
	5	●	MPS1120L-DIN	118	71	45	12	A
	5	●	MPS1120L-DIN-C	118	71	45	12	A
	8	●	MPS1120-L8C	178	129	45	12	A
	10	□	MPS1120-L10C	201	152	45	12	A
	12	●	MPS1120-L12C	224	175	45	12	A
	15	●	MPS1120-L15C	258	209	45	12	A
	20	□	MPS1120-L20C	316	267	45	12	A
	25	□	MPS1120-L25C	373	324	45	12	A
11.3	3	●	MPS1130S-DIN	102	55	45	12	A
	3	●	MPS1130S-DIN-C	102	55	45	12	A
	5	●	MPS1130L-DIN	118	71	45	12	A
	5	●	MPS1130L-DIN-C	118	71	45	12	A
	8	●	MPS1130-L8C	178	129	45	12	A
	10	□	MPS1130-L10C	201	152	45	12	A
	12	●	MPS1130-L12C	224	175	45	12	A
	15	●	MPS1130-L15C	258	209	45	12	A
	20	□	MPS1130-L20C	316	267	45	12	A
	25	□	MPS1130-L25C	373	324	45	12	A



Drill Dia. D1 (mm)	Hole Depth (l/d)	Stock		Order Number	Dimensions (mm)				Type
		VP15TF			L1	L3	L9	D4	
11.4	3	●		MPS1140S-DIN	102	55	45	12	A
	3	●		MPS1140S-DIN-C	102	55	45	12	A
	5	●		MPS1140L-DIN	118	71	45	12	A
	5	●		MPS1140L-DIN-C	118	71	45	12	A
	8	●		MPS1140-L8C	178	129	45	12	A
	10	□		MPS1140-L10C	201	152	45	12	A
	12	●		MPS1140-L12C	224	175	45	12	A
	15	●		MPS1140-L15C	258	209	45	12	A
	NEW 20	□		MPS1140-L20C	316	267	45	12	A
	NEW 25	□		MPS1140-L25C	373	324	45	12	A
NEW 20	□		MSL1140-L20C	316	267	45	12	B	
NEW 25	□		MSL1140-L25C	373	324	45	12	B	
11.5	3	●		MPS1150S-DIN	102	55	45	12	A
	3	●		MPS1150S-DIN-C	102	55	45	12	A
	5	●		MPS1150L-DIN	118	71	45	12	A
	5	●		MPS1150L-DIN-C	118	71	45	12	A
	8	●		MPS1150-L8C	178	129	45	12	A
	10	□		MPS1150-L10C	201	152	45	12	A
	12	●		MPS1150-L12C	224	175	45	12	A
	15	●		MPS1150-L15C	258	209	45	12	A
	NEW 20	□		MPS1150-L20C	316	267	45	12	A
	NEW 25	□		MPS1150-L25C	373	324	45	12	A
NEW 20	●		MSL1150-L20C	316	267	45	12	B	
NEW 25	●		MSL1150-L25C	373	324	45	12	B	
11.6	3	●		MPS1160S-DIN	102	55	45	12	A
	3	●		MPS1160S-DIN-C	102	55	45	12	A
	5	●		MPS1160L-DIN	118	71	45	12	A
	5	●		MPS1160L-DIN-C	118	71	45	12	A
	8	●		MPS1160-L8C	183	134	45	12	A
	10	□		MPS1160-L10C	207	158	45	12	A
	12	●		MPS1160-L12C	231	182	45	12	A
	15	●		MPS1160-L15C	267	218	45	12	A
	NEW 20	□		MPS1160-L20C	327	278	45	12	A
	NEW 25	□		MPS1160-L25C	387	338	45	12	A
NEW 20	□		MSL1160-L20C	327	278	45	12	B	
NEW 25	□		MSL1160-L25C	387	338	45	12	B	
11.7	3	●		MPS1170S-DIN	102	55	45	12	A
	3	●		MPS1170S-DIN-C	102	55	45	12	A
	5	●		MPS1170L-DIN	118	71	45	12	A
	5	●		MPS1170L-DIN-C	118	71	45	12	A
	8	●		MPS1170-L8C	183	134	45	12	A
	10	□		MPS1170-L10C	207	158	45	12	A
	12	●		MPS1170-L12C	231	182	45	12	A
	15	●		MPS1170-L15C	267	218	45	12	A
	NEW 20	□		MPS1170-L20C	327	278	45	12	A
	NEW 25	□		MPS1170-L25C	387	338	45	12	A
NEW 20	□		MSL1170-L20C	327	278	45	12	B	
NEW 25	□		MSL1170-L25C	387	338	45	12	B	
11.8	3	●		MPS1180S-DIN	102	55	45	12	A
	3	●		MPS1180S-DIN-C	102	55	45	12	A
	5	●		MPS1180L-DIN	118	71	45	12	A
	5	●		MPS1180L-DIN-C	118	71	45	12	A
	8	●		MPS1180-L8C	183	134	45	12	A
	10	□		MPS1180-L10C	207	158	45	12	A
	12	●		MPS1180-L12C	231	182	45	12	A
15	●		MPS1180-L15C	267	218	45	12	A	

Drill Dia. D1 (mm)	Hole Depth (l/d)	Stock		Order Number	Dimensions (mm)				Type
		VP15TF			L1	L3	L9	D4	
NEW 20	□			MPS1180-L20C	327	278	45	12	A
NEW 25	□			MPS1180-L25C	387	338	45	12	A
NEW 20	□			MSL1180-L20C	327	278	45	12	B
NEW 25	□			MSL1180-L25C	387	338	45	12	B
11.8	3	●		MPS1190S-DIN	102	55	45	12	A
	3	●		MPS1190S-DIN-C	102	55	45	12	A
	5	●		MPS1190L-DIN	118	71	45	12	A
	5	●		MPS1190L-DIN-C	118	71	45	12	A
	8	●		MPS1190-L8C	183	134	45	12	A
	10	□		MPS1190-L10C	207	158	45	12	A
	12	●		MPS1190-L12C	231	182	45	12	A
	15	●		MPS1190-L15C	267	218	45	12	A
	NEW 20	□		MPS1190-L20C	327	278	45	12	A
	NEW 25	□		MPS1190-L25C	387	338	45	12	A
NEW 20	□		MSL1190-L20C	327	278	45	12	B	
NEW 25	□		MSL1190-L25C	387	338	45	12	B	
11.9	3	●		MPS1200S-DIN	102	55	45	12	A
	3	●		MPS1200S-DIN-C	102	55	45	12	A
	5	●		MPS1200L-DIN	118	71	45	12	A
	5	●		MPS1200L-DIN-C	118	71	45	12	A
	8	●		MPS1200-L8C	183	134	45	12	A
	10	□		MPS1200-L10C	207	158	45	12	A
	12	●		MPS1200-L12C	231	182	45	12	A
	15	●		MPS1200-L15C	267	218	45	12	A
	NEW 20	□		MPS1200-L20C	327	278	45	12	A
	NEW 25	□		MPS1200-L25C	387	338	45	12	A
NEW 20	●		MSL1200-L20C	327	278	45	12	B	
NEW 25	●		MSL1200-L25C	387	338	45	12	B	
12.0	3	●		MPS1205S-DIN	107	60	45	14	A
	3	●		MPS1205S-DIN-C	107	60	45	14	A
	5	●		MPS1205L-DIN	124	77	45	14	A
	5	●		MPS1205L-DIN-C	124	77	45	14	A
	8	●		MPS1210S-DIN	107	60	45	14	A
	3	●		MPS1210S-DIN-C	107	60	45	14	A
	5	●		MPS1210L-DIN	124	77	45	14	A
	5	●		MPS1210L-DIN-C	124	77	45	14	A
	8	●		MPS1210-L8C	189	140	45	14	A
	10	□		MPS1210-L10C	214	165	45	14	A
12	●		MPS1210-L12C	239	190	45	14	A	
15	●		MPS1210-L15C	276	227	45	14	A	
NEW 20	□		MPS1210-L20C	339	290	45	14	A	
NEW 20	□		MSL1210-L20C	339	290	45	14	B	
12.05	3	●		MPS1220S-DIN	107	60	45	14	A
	3	●		MPS1220S-DIN-C	107	60	45	14	A
	5	●		MPS1220L-DIN	124	77	45	14	A
	5	●		MPS1220L-DIN-C	124	77	45	14	A
	8	●		MPS1220-L8C	189	140	45	14	A
	10	□		MPS1220-L10C	214	165	45	14	A
	12	●		MPS1220-L12C	239	190	45	14	A
	15	●		MPS1220-L15C	276	227	45	14	A
	NEW 20	□		MPS1220-L20C	339	290	45	14	A
	NEW 20	□		MSL1220-L20C	339	290	45	14	B



D1 Tolerance	3.0 ≤ D1 ≤ 6.0	6.0 < D1 ≤ 10.0	10.0 < D1 ≤ 18.0	18.0 < D1 ≤ 20.0
DIN type	0.010 -0.002	0.010 -0.005	0.005 -0.013	0.005 -0.016
Others	0 -0.012	0 -0.015	0 -0.018	0 -0.021

\* MPS-DIN type see table above. Other MPS/MSL drills h7 tolerance.

## ● Type A Double margin type

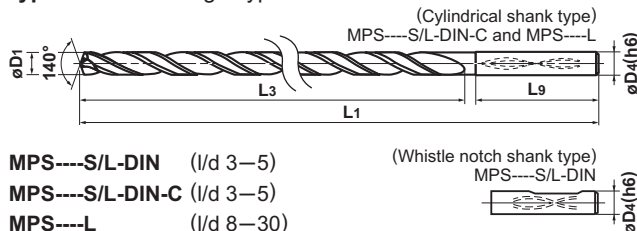

MPS---S/L-DIN (l/d 3-5)

MPS---S/L-DIN-C (l/d 3-5)

MPS---L (l/d 8-30)

Drill Dia. D1 (mm)	Hole Depth (l/d)	Stock VP15TF	Order Number	Dimensions (mm)				Type
				L1	L3	L9	D4	
12.3	3	●	MPS1230S-DIN	107	60	45	14	A
	3	●	MPS1230S-DIN-C	107	60	45	14	A
	5	●	MPS1230L-DIN	124	77	45	14	A
	5	●	MPS1230L-DIN-C	124	77	45	14	A
	8	●	MPS1230-L8C	189	140	45	14	A
	10	□	MPS1230-L10C	214	165	45	14	A
	12	●	MPS1230-L12C	239	190	45	14	A
	15	●	MPS1230-L15C	276	227	45	14	A
NEW	20	□	MPS1230-L20C	339	290	45	14	A
NEW	20	□	MSL1230-L20C	339	290	45	14	B
12.4	3	●	MPS1240S-DIN	107	60	45	14	A
	3	●	MPS1240S-DIN-C	107	60	45	14	A
	5	●	MPS1240L-DIN	124	77	45	14	A
	5	●	MPS1240L-DIN-C	124	77	45	14	A
	8	●	MPS1240-L8C	189	140	45	14	A
	10	□	MPS1240-L10C	214	165	45	14	A
	12	●	MPS1240-L12C	239	190	45	14	A
	15	●	MPS1240-L15C	276	227	45	14	A
NEW	20	□	MPS1240-L20C	339	290	45	14	A
NEW	20	□	MSL1240-L20C	339	290	45	14	B
12.5	3	●	MPS1250S-DIN	107	60	45	14	A
	3	●	MPS1250S-DIN-C	107	60	45	14	A
	5	●	MPS1250L-DIN	124	77	45	14	A
	5	●	MPS1250L-DIN-C	124	77	45	14	A
	8	●	MPS1250-L8C	189	140	45	14	A
	10	□	MPS1250-L10C	214	165	45	14	A
	12	●	MPS1250-L12C	239	190	45	14	A
	15	●	MPS1250-L15C	276	227	45	14	A
NEW	20	●	MPS1250-L20C	339	290	45	14	A
NEW	20	●	MSL1250-L20C	339	290	45	14	B
12.6	3	●	MPS1260S-DIN	107	60	45	14	A
	3	●	MPS1260S-DIN-C	107	60	45	14	A
	5	●	MPS1260L-DIN	124	77	45	14	A
	5	●	MPS1260L-DIN-C	124	77	45	14	A
	8	●	MPS1260-L8C	194	145	45	14	A
	10	□	MPS1260-L10C	220	171	45	14	A
	12	●	MPS1260-L12C	246	197	45	14	A
	15	●	MPS1260-L15C	285	236	45	14	A
NEW	20	□	MPS1260-L20C	350	301	45	14	A
NEW	20	□	MSL1260-L20C	350	301	45	14	B

Drill Dia. D1 (mm)	Hole Depth (l/d)	Stock VP15TF	Order Number	Dimensions (mm)				Type
				L1	L3	L9	D4	
12.7	3	●	MPS1270S-DIN	107	60	45	14	A
	3	●	MPS1270S-DIN-C	107	60	45	14	A
	5	●	MPS1270L-DIN	124	77	45	14	A
	5	●	MPS1270L-DIN-C	124	77	45	14	A
	8	●	MPS1270-L8C	194	145	45	14	A
	10	□	MPS1270-L10C	220	171	45	14	A
	12	●	MPS1270-L12C	246	197	45	14	A
	15	●	MPS1270-L15C	285	236	45	14	A
NEW	20	□	MPS1270-L20C	350	301	45	14	A
NEW	20	□	MSL1270-L20C	350	301	45	14	B
12.8	3	●	MPS1280S-DIN	107	60	45	14	A
	3	●	MPS1280S-DIN-C	107	60	45	14	A
	5	●	MPS1280L-DIN	124	77	45	14	A
	5	●	MPS1280L-DIN-C	124	77	45	14	A
	8	●	MPS1280-L8C	194	145	45	14	A
	10	□	MPS1280-L10C	220	171	45	14	A
	12	●	MPS1280-L12C	246	197	45	14	A
	15	●	MPS1280-L15C	285	236	45	14	A
NEW	20	□	MPS1280-L20C	350	301	45	14	A
NEW	20	□	MSL1280-L20C	350	301	45	14	B
12.9	3	●	MPS1290S-DIN	107	60	45	14	A
	3	●	MPS1290S-DIN-C	107	60	45	14	A
	5	●	MPS1290L-DIN	124	77	45	14	A
	5	●	MPS1290L-DIN-C	124	77	45	14	A
	8	●	MPS1290-L8C	194	145	45	14	A
	10	□	MPS1290-L10C	220	171	45	14	A
	12	●	MPS1290-L12C	246	197	45	14	A
	15	●	MPS1290-L15C	285	236	45	14	A
NEW	20	□	MPS1290-L20C	350	301	45	14	A
NEW	20	□	MSL1290-L20C	350	301	45	14	B
13.0	3	●	MPS1300S-DIN	107	60	45	14	A
	3	●	MPS1300S-DIN-C	107	60	45	14	A
	5	●	MPS1300L-DIN	124	77	45	14	A
	5	●	MPS1300L-DIN-C	124	77	45	14	A
	8	●	MPS1300-L8C	194	145	45	14	A
	10	□	MPS1300-L10C	220	171	45	14	A
	12	●	MPS1300-L12C	246	197	45	14	A
	15	●	MPS1300-L15C	285	236	45	14	A
NEW	20	●	MPS1300-L20C	350	301	45	14	A
NEW	20	●	MSL1300-L20C	350	301	45	14	B

Drill Dia. D1 (mm)	Hole Depth (l/d)	Stock		Order Number	Dimensions (mm)				Type
		VP15TF			L1	L3	L9	D4	
13.1	3	●		MPS1310S-DIN	107	60	45	14	A
	3	●		MPS1310S-DIN-C	107	60	45	14	A
	5	●		MPS1310L-DIN	124	77	45	14	A
	5	●		MPS1310L-DIN-C	124	77	45	14	A
	8	●		MPS1310-L8C	200	151	45	14	A
	10	□		MPS1310-L10C	227	178	45	14	A
	12	●		MPS1310-L12C	254	205	45	14	A
	15	●		MPS1310-L15C	294	245	45	14	A
	NEW 20	□		MPS1310-L20C	362	313	45	14	A
	NEW 20	□		MSL1310-L20C	362	313	45	14	B
13.2	3	●		MPS1320S-DIN	107	60	45	14	A
	3	●		MPS1320S-DIN-C	107	60	45	14	A
	5	●		MPS1320L-DIN	124	77	45	14	A
	5	●		MPS1320L-DIN-C	124	77	45	14	A
	8	●		MPS1320-L8C	200	151	45	14	A
	10	□		MPS1320-L10C	227	178	45	14	A
	12	●		MPS1320-L12C	254	205	45	14	A
	15	●		MPS1320-L15C	294	245	45	14	A
	NEW 20	□		MPS1320-L20C	362	313	45	14	A
	NEW 20	□		MSL1320-L20C	362	313	45	14	B
13.3	3	●		MPS1330S-DIN	107	60	45	14	A
	3	●		MPS1330S-DIN-C	107	60	45	14	A
	5	●		MPS1330L-DIN	124	77	45	14	A
	5	●		MPS1330L-DIN-C	124	77	45	14	A
	8	●		MPS1330-L8C	200	151	45	14	A
	10	□		MPS1330-L10C	227	178	45	14	A
	12	●		MPS1330-L12C	254	205	45	14	A
	15	●		MPS1330-L15C	294	245	45	14	A
	NEW 20	□		MPS1330-L20C	362	313	45	14	A
	NEW 20	□		MSL1330-L20C	362	313	45	14	B
13.4	3	●		MPS1340S-DIN	107	60	45	14	A
	3	●		MPS1340S-DIN-C	107	60	45	14	A
	5	●		MPS1340L-DIN	124	77	45	14	A
	5	●		MPS1340L-DIN-C	124	77	45	14	A
	8	●		MPS1340-L8C	200	151	45	14	A
	10	□		MPS1340-L10C	227	178	45	14	A
	12	●		MPS1340-L12C	254	205	45	14	A
	15	●		MPS1340-L15C	294	245	45	14	A
	NEW 20	□		MPS1340-L20C	362	313	45	14	A
	NEW 20	□		MSL1340-L20C	362	313	45	14	B
13.5	3	●		MPS1350S-DIN	107	60	45	14	A
	3	●		MPS1350S-DIN-C	107	60	45	14	A
	5	●		MPS1350L-DIN	124	77	45	14	A
	5	●		MPS1350L-DIN-C	124	77	45	14	A
	8	●		MPS1350-L8C	200	151	45	14	A
	10	□		MPS1350-L10C	227	178	45	14	A
	12	●		MPS1350-L12C	254	205	45	14	A
	15	●		MPS1350-L15C	294	245	45	14	A
	NEW 20	●		MPS1350-L20C	362	313	45	14	A
	NEW 20	●		MSL1350-L20C	362	313	45	14	B
13.6	3	●		MPS1360S-DIN	107	60	45	14	A
	3	●		MPS1360S-DIN-C	107	60	45	14	A
	5	●		MPS1360L-DIN	124	77	45	14	A
	5	●		MPS1360L-DIN-C	124	77	45	14	A
	8	●		MPS1360-L8C	205	156	45	14	A
	10	□		MPS1360-L10C	233	184	45	14	A

Drill Dia. D1 (mm)	Hole Depth (l/d)	Stock		Order Number	Dimensions (mm)				Type
		VP15TF			L1	L3	L9	D4	
13.6	12	●		MPS1360-L12C	261	212	45	14	A
	15	●		MPS1360-L15C	303	254	45	14	A
	NEW 20	□		MPS1360-L20C	373	324	45	14	A
	NEW 20	□		MSL1360-L20C	373	324	45	14	B
13.7	3	●		MPS1370S-DIN	107	60	45	14	A
	3	●		MPS1370S-DIN-C	107	60	45	14	A
	5	●		MPS1370L-DIN	124	77	45	14	A
	5	●		MPS1370L-DIN-C	124	77	45	14	A
	8	●		MPS1370-L8C	205	156	45	14	A
	10	□		MPS1370-L10C	233	184	45	14	A
	12	●		MPS1370-L12C	261	212	45	14	A
	15	●		MPS1370-L15C	303	254	45	14	A
	NEW 20	□		MPS1370-L20C	373	324	45	14	A
	NEW 20	□		MSL1370-L20C	373	324	45	14	B
13.8	3	●		MPS1380S-DIN	107	60	45	14	A
	3	●		MPS1380S-DIN-C	107	60	45	14	A
	5	●		MPS1380L-DIN	124	77	45	14	A
	5	●		MPS1380L-DIN-C	124	77	45	14	A
	8	●		MPS1380-L8C	205	156	45	14	A
	10	□		MPS1380-L10C	233	184	45	14	A
	12	●		MPS1380-L12C	261	212	45	14	A
	15	●		MPS1380-L15C	303	254	45	14	A
	NEW 20	□		MPS1380-L20C	373	324	45	14	A
	NEW 20	□		MSL1380-L20C	373	324	45	14	B
13.9	3	●		MPS1390S-DIN	107	60	45	14	A
	3	●		MPS1390S-DIN-C	107	60	45	14	A
	5	●		MPS1390L-DIN	124	77	45	14	A
	5	●		MPS1390L-DIN-C	124	77	45	14	A
	8	●		MPS1390-L8C	205	156	45	14	A
	10	□		MPS1390-L10C	233	184	45	14	A
	12	●		MPS1390-L12C	261	212	45	14	A
	15	●		MPS1390-L15C	303	254	45	14	A
	NEW 20	□		MPS1390-L20C	373	324	45	14	A
	NEW 20	□		MSL1390-L20C	373	324	45	14	B
14.0	3	●		MPS1400S-DIN	107	60	45	14	A
	3	●		MPS1400S-DIN-C	107	60	45	14	A
	5	●		MPS1400L-DIN	124	77	45	14	A
	5	●		MPS1400L-DIN-C	124	77	45	14	A
	8	●		MPS1400-L8C	205	156	45	14	A
	10	□		MPS1400-L10C	233	184	45	14	A
	12	●		MPS1400-L12C	261	212	45	14	A
	15	●		MPS1400-L15C	303	254	45	14	A
	NEW 20	●		MPS1400-L20C	373	324	45	14	A
	NEW 20	●		MSL1400-L20C	373	324	45	14	B
14.1	3	□		MPS1410S-DIN	114	64	48	16	A
	3	□		MPS1410S-DIN-C	114	64	48	16	A
	5	□		MPS1410L-DIN	132	82	48	16	A
	5	□		MPS1410L-DIN-C	132	82	48	16	A
14.2	3	●		MPS1420S-DIN	114	64	48	16	A
	3	●		MPS1420S-DIN-C	114	64	48	16	A
	5	●		MPS1420L-DIN	132	82	48	16	A
14.3	3	□		MPS1430S-DIN	114	64	48	16	A
	3	□		MPS1430S-DIN-C	114	64	48	16	A
	5	□		MPS1430L-DIN	132	82	48	16	A
14.3	5	□		MPS1430L-DIN	132	82	48	16	A
	5	□		MPS1430L-DIN-C	132	82	48	16	A
	5	□		MPS1430L-DIN-C	132	82	48	16	A



D1 Tolerance	3.0 ≤ D1 ≤ 6.0	6.0 < D1 ≤ 10.0	10.0 < D1 ≤ 18.0	18.0 < D1 ≤ 20.0
DIN type	0.010 -0.002	0.010 -0.005	0.005 -0.013	0.005 -0.016
Others	0 -0.012	0 -0.015	0 -0.018	0 -0.021

\* MPS-DIN type see table above. Other MPS/MSL drills h7 tolerance.

### ● Type A Double margin type

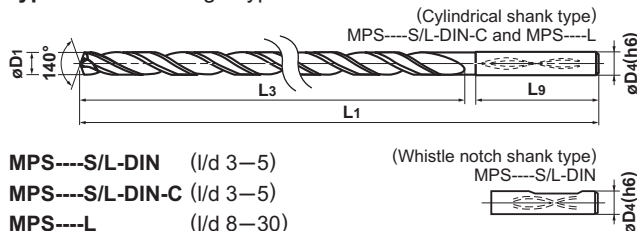

Drill Dia. D1 (mm)	Hole Depth (l/d)	Stock VP15TF	Order Number	Dimensions (mm)				Type
				L1	L3	L9	D4	
14.4	3	□	MPS1440S-DIN	114	64	48	16	A
	3	□	MPS1440S-DIN-C	114	64	48	16	A
	5	□	MPS1440L-DIN	132	82	48	16	A
	5	□	MPS1440L-DIN-C	132	82	48	16	A
14.5	3	●	MPS1450S-DIN	114	64	48	16	A
	3	●	MPS1450S-DIN-C	114	64	48	16	A
	5	●	MPS1450L-DIN	132	82	48	16	A
	5	●	MPS1450L-DIN-C	132	82	48	16	A
14.6	3	□	MPS1460S-DIN	114	64	48	16	A
	3	□	MPS1460S-DIN-C	114	64	48	16	A
	5	□	MPS1460L-DIN	132	82	48	16	A
	5	□	MPS1460L-DIN-C	132	82	48	16	A
14.7	3	□	MPS1470S-DIN	114	64	48	16	A
	3	□	MPS1470S-DIN-C	114	64	48	16	A
	5	□	MPS1470L-DIN	132	82	48	16	A
	5	□	MPS1470L-DIN-C	132	82	48	16	A
14.8	3	□	MPS1480S-DIN	114	64	48	16	A
	3	□	MPS1480S-DIN-C	114	64	48	16	A
	5	□	MPS1480L-DIN	132	82	48	16	A
	5	□	MPS1480L-DIN-C	132	82	48	16	A
14.9	3	□	MPS1490S-DIN	114	64	48	16	A
	3	□	MPS1490S-DIN-C	114	64	48	16	A
	5	□	MPS1490L-DIN	132	82	48	16	A
	5	□	MPS1490L-DIN-C	132	82	48	16	A
15.0	3	●	MPS1500S-DIN	114	64	48	16	A
	3	●	MPS1500S-DIN-C	114	64	48	16	A
	5	●	MPS1500L-DIN	132	82	48	16	A
	5	●	MPS1500L-DIN-C	132	82	48	16	A
15.1	3	□	MPS1510S-DIN	115	65	48	16	A
	3	□	MPS1510S-DIN-C	115	65	48	16	A
	5	□	MPS1510L-DIN	133	83	48	16	A
	5	□	MPS1510L-DIN-C	133	83	48	16	A
15.2	3	□	MPS1520S-DIN	115	65	48	16	A
	3	□	MPS1520S-DIN-C	115	65	48	16	A
	5	□	MPS1520L-DIN	133	83	48	16	A
	5	□	MPS1520L-DIN-C	133	83	48	16	A
15.3	3	□	MPS1530S-DIN	115	65	48	16	A
	3	□	MPS1530S-DIN-C	115	65	48	16	A
	5	□	MPS1530L-DIN	133	83	48	16	A
	5	□	MPS1530L-DIN-C	133	83	48	16	A

Drill Dia. D1 (mm)	Hole Depth (l/d)	Stock VP15TF	Order Number	Dimensions (mm)				Type
				L1	L3	L9	D4	
15.4	3	□	MPS1540S-DIN	115	65	48	16	A
	3	□	MPS1540S-DIN-C	115	65	48	16	A
	5	□	MPS1540L-DIN	133	83	48	16	A
	5	□	MPS1540L-DIN-C	133	83	48	16	A
15.5	3	●	MPS1550S-DIN	115	65	48	16	A
	3	●	MPS1550S-DIN-C	115	65	48	16	A
	5	●	MPS1550L-DIN	133	83	48	16	A
	5	●	MPS1550L-DIN-C	133	83	48	16	A
15.6	3	□	MPS1560S-DIN	115	65	48	16	A
	3	□	MPS1560S-DIN-C	115	65	48	16	A
	5	□	MPS1560L-DIN	133	83	48	16	A
	5	□	MPS1560L-DIN-C	133	83	48	16	A
15.7	3	□	MPS1570S-DIN	115	65	48	16	A
	3	□	MPS1570S-DIN-C	115	65	48	16	A
	5	□	MPS1570L-DIN	133	83	48	16	A
	5	□	MPS1570L-DIN-C	133	83	48	16	A
15.8	3	□	MPS1580S-DIN	115	65	48	16	A
	3	□	MPS1580S-DIN-C	115	65	48	16	A
	5	□	MPS1580L-DIN	133	83	48	16	A
	5	□	MPS1580L-DIN-C	133	83	48	16	A
15.9	3	□	MPS1590S-DIN	115	65	48	16	A
	3	□	MPS1590S-DIN-C	115	65	48	16	A
	5	□	MPS1590L-DIN	133	83	48	16	A
	5	□	MPS1590L-DIN-C	133	83	48	16	A
16.0	3	●	MPS1600S-DIN	115	65	48	16	A
	3	●	MPS1600S-DIN-C	115	65	48	16	A
	5	●	MPS1600L-DIN	133	83	48	16	A
	5	●	MPS1600L-DIN-C	133	83	48	16	A
16.1	3	□	MPS1610S-DIN	123	73	48	18	A
	3	□	MPS1610S-DIN-C	123	73	48	18	A
	5	□	MPS1610L-DIN	143	93	48	18	A
	5	□	MPS1610L-DIN-C	143	93	48	18	A
16.2	3	□	MPS1620S-DIN	123	73	48	18	A
	3	□	MPS1620S-DIN-C	123	73	48	18	A
	5	□	MPS1620L-DIN	143	93	48	18	A
	5	□	MPS1620L-DIN-C	143	93	48	18	A
16.3	3	□	MPS1630S-DIN	123	73	48	18	A
	3	□	MPS1630S-DIN-C	123	73	48	18	A
	5	□	MPS1630L-DIN	143	93	48	18	A
	5	□	MPS1630L-DIN-C	143	93	48	18	A



Drill Dia. D1 (mm)	Hole Depth (l/d)	Stock		Order Number	Dimensions (mm)				Type
		VP15TF			L1	L3	L9	D4	
16.4	3	<input type="checkbox"/>		MPS1640S-DIN	123	73	48	18	A
	3	<input type="checkbox"/>		MPS1640S-DIN-C	123	73	48	18	A
	5	<input type="checkbox"/>		MPS1640L-DIN	143	93	48	18	A
	5	<input type="checkbox"/>		MPS1640L-DIN-C	143	93	48	18	A
16.5	3	<input checked="" type="checkbox"/>		MPS1650S-DIN	123	73	48	18	A
	3	<input checked="" type="checkbox"/>		MPS1650S-DIN-C	123	73	48	18	A
	5	<input checked="" type="checkbox"/>		MPS1650L-DIN	143	93	48	18	A
	5	<input checked="" type="checkbox"/>		MPS1650L-DIN-C	143	93	48	18	A
16.6	3	<input type="checkbox"/>		MPS1660S-DIN	123	73	48	18	A
	3	<input type="checkbox"/>		MPS1660S-DIN-C	123	73	48	18	A
	5	<input type="checkbox"/>		MPS1660L-DIN	143	93	48	18	A
	5	<input type="checkbox"/>		MPS1660L-DIN-C	143	93	48	18	A
16.7	3	<input type="checkbox"/>		MPS1670S-DIN	123	73	48	18	A
	3	<input type="checkbox"/>		MPS1670S-DIN-C	123	73	48	18	A
	5	<input type="checkbox"/>		MPS1670L-DIN	143	93	48	18	A
	5	<input type="checkbox"/>		MPS1670L-DIN-C	143	93	48	18	A
16.8	3	<input type="checkbox"/>		MPS1680S-DIN	123	73	48	18	A
	3	<input type="checkbox"/>		MPS1680S-DIN-C	123	73	48	18	A
	5	<input type="checkbox"/>		MPS1680L-DIN	143	93	48	18	A
	5	<input type="checkbox"/>		MPS1680L-DIN-C	143	93	48	18	A
16.9	3	<input type="checkbox"/>		MPS1690S-DIN	123	73	48	18	A
	3	<input type="checkbox"/>		MPS1690S-DIN-C	123	73	48	18	A
	5	<input type="checkbox"/>		MPS1690L-DIN	143	93	48	18	A
	5	<input type="checkbox"/>		MPS1690L-DIN-C	143	93	48	18	A
17.0	3	<input checked="" type="checkbox"/>		MPS1700S-DIN	123	73	48	18	A
	3	<input checked="" type="checkbox"/>		MPS1700S-DIN-C	123	73	48	18	A
	5	<input checked="" type="checkbox"/>		MPS1700L-DIN	143	93	48	18	A
	5	<input checked="" type="checkbox"/>		MPS1700L-DIN-C	143	93	48	18	A
17.1	3	<input type="checkbox"/>		MPS1710S-DIN	123	73	48	18	A
	3	<input type="checkbox"/>		MPS1710S-DIN-C	123	73	48	18	A
	5	<input type="checkbox"/>		MPS1710L-DIN	143	93	48	18	A
	5	<input type="checkbox"/>		MPS1710L-DIN-C	143	93	48	18	A
17.2	3	<input type="checkbox"/>		MPS1720S-DIN	123	73	48	18	A
	3	<input type="checkbox"/>		MPS1720S-DIN-C	123	73	48	18	A
	5	<input type="checkbox"/>		MPS1720L-DIN	143	93	48	18	A
	5	<input type="checkbox"/>		MPS1720L-DIN-C	143	93	48	18	A
17.3	3	<input type="checkbox"/>		MPS1730S-DIN	123	73	48	18	A
	3	<input type="checkbox"/>		MPS1730S-DIN-C	123	73	48	18	A
	5	<input type="checkbox"/>		MPS1730L-DIN	143	93	48	18	A
	5	<input type="checkbox"/>		MPS1730L-DIN-C	143	93	48	18	A
17.4	3	<input type="checkbox"/>		MPS1740S-DIN	123	73	48	18	A
	3	<input type="checkbox"/>		MPS1740S-DIN-C	123	73	48	18	A
	5	<input type="checkbox"/>		MPS1740L-DIN	143	93	48	18	A
	5	<input type="checkbox"/>		MPS1740L-DIN-C	143	93	48	18	A
17.5	3	<input checked="" type="checkbox"/>		MPS1750S-DIN	123	73	48	18	A
	3	<input checked="" type="checkbox"/>		MPS1750S-DIN-C	123	73	48	18	A
	5	<input checked="" type="checkbox"/>		MPS1750L-DIN	143	93	48	18	A
	5	<input checked="" type="checkbox"/>		MPS1750L-DIN-C	143	93	48	18	A
17.6	3	<input type="checkbox"/>		MPS1760S-DIN	123	73	48	18	A
	3	<input type="checkbox"/>		MPS1760S-DIN-C	123	73	48	18	A
	5	<input type="checkbox"/>		MPS1760L-DIN	143	93	48	18	A
	5	<input type="checkbox"/>		MPS1760L-DIN-C	143	93	48	18	A
17.7	3	<input type="checkbox"/>		MPS1770S-DIN	123	73	48	18	A
	3	<input type="checkbox"/>		MPS1770S-DIN-C	123	73	48	18	A
	5	<input type="checkbox"/>		MPS1770L-DIN	143	93	48	18	A
	5	<input type="checkbox"/>		MPS1770L-DIN-C	143	93	48	18	A

Drill Dia. D1 (mm)	Hole Depth (l/d)	Stock		Order Number	Dimensions (mm)				Type
		VP15TF			L1	L3	L9	D4	
17.8	3	<input type="checkbox"/>		MPS1780S-DIN	123	73	48	18	A
	3	<input type="checkbox"/>		MPS1780S-DIN-C	123	73	48	18	A
	5	<input type="checkbox"/>		MPS1780L-DIN	143	93	48	18	A
	5	<input type="checkbox"/>		MPS1780L-DIN-C	143	93	48	18	A
17.9	3	<input type="checkbox"/>		MPS1790S-DIN	123	73	48	18	A
	3	<input type="checkbox"/>		MPS1790S-DIN-C	123	73	48	18	A
	5	<input type="checkbox"/>		MPS1790L-DIN	143	93	48	18	A
	5	<input type="checkbox"/>		MPS1790L-DIN-C	143	93	48	18	A
18.0	3	<input checked="" type="checkbox"/>		MPS1800S-DIN	123	73	48	18	A
	3	<input checked="" type="checkbox"/>		MPS1800S-DIN-C	123	73	48	18	A
	5	<input checked="" type="checkbox"/>		MPS1800L-DIN	143	93	48	18	A
	5	<input checked="" type="checkbox"/>		MPS1800L-DIN-C	143	93	48	18	A
18.1	3	<input type="checkbox"/>		MPS1810S-DIN	131	79	50	20	A
	3	<input type="checkbox"/>		MPS1810S-DIN-C	131	79	50	20	A
	5	<input type="checkbox"/>		MPS1810L-DIN	153	101	50	20	A
	5	<input type="checkbox"/>		MPS1810L-DIN-C	153	101	50	20	A
18.2	3	<input type="checkbox"/>		MPS1820S-DIN	131	79	50	20	A
	3	<input type="checkbox"/>		MPS1820S-DIN-C	131	79	50	20	A
	5	<input type="checkbox"/>		MPS1820L-DIN	153	101	50	20	A
	5	<input type="checkbox"/>		MPS1820L-DIN-C	153	101	50	20	A
18.3	3	<input type="checkbox"/>		MPS1830S-DIN	131	79	50	20	A
	3	<input type="checkbox"/>		MPS1830S-DIN-C	131	79	50	20	A
	5	<input type="checkbox"/>		MPS1830L-DIN	153	101	50	20	A
	5	<input type="checkbox"/>		MPS1830L-DIN-C	153	101	50	20	A
18.4	3	<input type="checkbox"/>		MPS1840S-DIN	131	79	50	20	A
	3	<input type="checkbox"/>		MPS1840S-DIN-C	131	79	50	20	A
	5	<input type="checkbox"/>		MPS1840L-DIN	153	101	50	20	A
	5	<input type="checkbox"/>		MPS1840L-DIN-C	153	101	50	20	A
18.5	3	<input checked="" type="checkbox"/>		MPS1850S-DIN	131	79	50	20	A
	3	<input checked="" type="checkbox"/>		MPS1850S-DIN-C	131	79	50	20	A
	5	<input checked="" type="checkbox"/>		MPS1850L-DIN	153	101	50	20	A
	5	<input checked="" type="checkbox"/>		MPS1850L-DIN-C	153	101	50	20	A
18.6	3	<input type="checkbox"/>		MPS1860S-DIN	131	79	50	20	A
	3	<input type="checkbox"/>		MPS1860S-DIN-C	131	79	50	20	A
	5	<input type="checkbox"/>		MPS1860L-DIN	153	101	50	20	A
	5	<input type="checkbox"/>		MPS1860L-DIN-C	153	101	50	20	A
18.7	3	<input type="checkbox"/>		MPS1870S-DIN	131	79	50	20	A
	3	<input type="checkbox"/>		MPS1870S-DIN-C	131	79	50	20	A
	5	<input type="checkbox"/>		MPS1870L-DIN	153	101	50	20	A
	5	<input type="checkbox"/>		MPS1870L-DIN-C	153	101	50	20	A
18.8	3	<input type="checkbox"/>		MPS1880S-DIN	131	79	50	20	A
	3	<input type="checkbox"/>		MPS1880S-DIN-C	131	79	50	20	A
	5	<input type="checkbox"/>		MPS1880L-DIN	153	101	50	20	A
	5	<input type="checkbox"/>		MPS1880L-DIN-C	153	101	50	20	A
18.9	3	<input type="checkbox"/>		MPS1890S-DIN	131	79	50	20	A
	3	<input type="checkbox"/>		MPS1890S-DIN-C	131	79	50	20	A
	5	<input type="checkbox"/>		MPS1890L-DIN	153	101	50	20	A
	5	<input type="checkbox"/>		MPS1890L-DIN-C	153	101	50	20	A
19.0	3	<input checked="" type="checkbox"/>		MPS1900S-DIN	131	79	50	20	A
	3	<input checked="" type="checkbox"/>		MPS1900S-DIN-C	131	79	50	20	A
	5	<input checked="" type="checkbox"/>		MPS1900L-DIN	153	101	50	20	A
	5	<input checked="" type="checkbox"/>		MPS1900L-DIN-C	153	101	50	20	A
19.1	3	<input type="checkbox"/>		MPS1910S-DIN	131	79	50	20	A
	3	<input type="checkbox"/>		MPS1910S-DIN-C	131	79	50	20	A
	5	<input type="checkbox"/>		MPS1910L-DIN	153	101	50	20	A
	5	<input type="checkbox"/>		MPS1910L-DIN-C	153	101	50	20	A



D1 Tolerance	3.0 ≤ D1 ≤ 6.0	6.0 < D1 ≤ 10.0	10.0 < D1 ≤ 18.0	18.0 < D1 ≤ 20.0
DIN type	0.010 -0.002	0.010 -0.005	0.005 -0.013	0.005 -0.016
Others	0 -0.012	0 -0.015	0 -0.018	0 -0.021

\* MPS-DIN type see table above. Other MPS/MSL drills h7 tolerance.

### ● Type A Double margin type

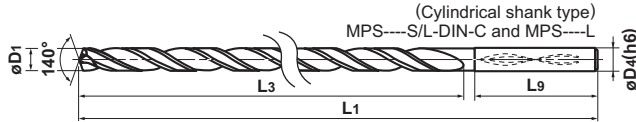

MPS---S/L-DIN (l/d 3-5)

MPS---S/L-DIN-C (l/d 3-5)

MPS---L (l/d 8-30)

(Whistle notch shank type)

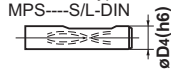

Drill Dia. D1 (mm)	Hole Depth (l/d)	Stock VP15TF	Order Number	Dimensions (mm)				Type
				L1	L3	L9	D4	
19.2	3	<input type="checkbox"/>	MPS1920S-DIN	131	79	50	20	A
	3	<input type="checkbox"/>	MPS1920S-DIN-C	131	79	50	20	A
	5	<input type="checkbox"/>	MPS1920L-DIN	153	101	50	20	A
	5	<input type="checkbox"/>	MPS1920L-DIN-C	153	101	50	20	A
19.3	3	<input type="checkbox"/>	MPS1930S-DIN	131	79	50	20	A
	3	<input type="checkbox"/>	MPS1930S-DIN-C	131	79	50	20	A
	5	<input type="checkbox"/>	MPS1930L-DIN	153	101	50	20	A
	5	<input type="checkbox"/>	MPS1930L-DIN-C	153	101	50	20	A
19.4	3	<input type="checkbox"/>	MPS1940S-DIN	131	79	50	20	A
	3	<input type="checkbox"/>	MPS1940S-DIN-C	131	79	50	20	A
	5	<input type="checkbox"/>	MPS1940L-DIN	153	101	50	20	A
	5	<input type="checkbox"/>	MPS1940L-DIN-C	153	101	50	20	A
19.5	3	<input checked="" type="checkbox"/>	MPS1950S-DIN	131	79	50	20	A
	3	<input checked="" type="checkbox"/>	MPS1950S-DIN-C	131	79	50	20	A
	5	<input checked="" type="checkbox"/>	MPS1950L-DIN	153	101	50	20	A
	5	<input checked="" type="checkbox"/>	MPS1950L-DIN-C	153	101	50	20	A
19.6	3	<input type="checkbox"/>	MPS1960S-DIN	131	79	50	20	A
	3	<input type="checkbox"/>	MPS1960S-DIN-C	131	79	50	20	A
	5	<input type="checkbox"/>	MPS1960L-DIN	153	101	50	20	A
	5	<input type="checkbox"/>	MPS1960L-DIN-C	153	101	50	20	A

Drill Dia. D1 (mm)	Hole Depth (l/d)	Stock VP15TF	Order Number	Dimensions (mm)				Type
				L1	L3	L9	D4	
19.7	3	<input type="checkbox"/>	MPS1970S-DIN	131	79	50	20	A
	3	<input type="checkbox"/>	MPS1970S-DIN-C	131	79	50	20	A
	5	<input type="checkbox"/>	MPS1970L-DIN	153	101	50	20	A
	5	<input type="checkbox"/>	MPS1970L-DIN-C	153	101	50	20	A
19.8	3	<input type="checkbox"/>	MPS1980S-DIN	131	79	50	20	A
	3	<input type="checkbox"/>	MPS1980S-DIN-C	131	79	50	20	A
	5	<input type="checkbox"/>	MPS1980L-DIN	153	101	50	20	A
	5	<input type="checkbox"/>	MPS1980L-DIN-C	153	101	50	20	A
19.9	3	<input type="checkbox"/>	MPS1990S-DIN	131	79	50	20	A
	3	<input type="checkbox"/>	MPS1990S-DIN-C	131	79	50	20	A
	5	<input type="checkbox"/>	MPS1990L-DIN	153	101	50	20	A
	5	<input type="checkbox"/>	MPS1990L-DIN-C	153	101	50	20	A
20.0	3	<input checked="" type="checkbox"/>	MPS2000S-DIN	131	79	50	20	A
	3	<input checked="" type="checkbox"/>	MPS2000S-DIN-C	131	79	50	20	A
	5	<input checked="" type="checkbox"/>	MPS2000L-DIN	153	101	50	20	A
	5	<input checked="" type="checkbox"/>	MPS2000L-DIN-C	153	101	50	20	A

## Operational Guidance

### ● Guidance for pilot hole drilling and breaking through on irregular and angled surfaces.

#### Use Drilling a blind hole

##### 1. Drilling a pilot hole

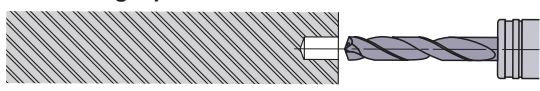

- ① Use a drill with a larger (flatter) point angle than the super long type. Mitsubishi type MZE, MZS or MS is recommended.
- ② Use a drill with the same diameter as the deep hole drill.
- ③ Drill depth : Approx 2-3D or deeper.
- ④ Ensure a high precision hole is drilled for the guide.

##### 2. Initial cutting with the long type drill.

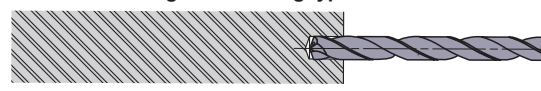

- ① Penetrate the guide hole at low revolution. (n=300), and a feed rate of Vf=1000
- ② Stop the long type drill 0,5mm-1mm short of the guide hole bottom.

##### 3. Drill the deep hole

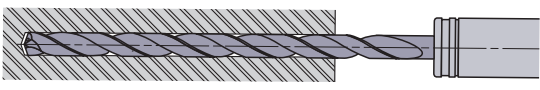

- ① Start cutting at the recommended speed and feed with a non-peck (continuous feed) cycle.

##### 4. Drill retraction

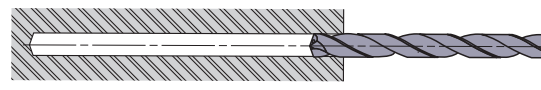

- ① Retract the drill to the pilot hole depth starting point at a feed rate of 3000mm/min.
- ② Finally clear the hole at low revolution. (n=300), and a feed rate of Vf=3000

#### Use Drilling and breaking through on irregular faces or angles

##### 1. Spot facing

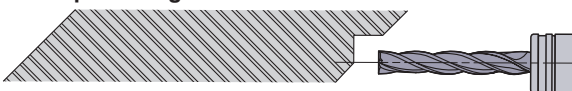

- ① Machine a flat or the irregular face by using an end mill or slot drill capable of spot facing. Make the spot face diameter the same size as the required deep hole diameter.

##### 2. Drilling a pilot hole

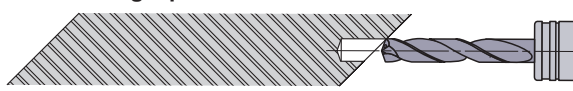

- ① Use a drill with a larger (flatter) point angle than the super long type. Mitsubishi type MZE, MZS or MS is recommended.
- ② Use a drill with the same diameter as the deep hole drill.
- ③ Drill depth : Approx 2-3D or deeper.
- ④ Ensure a high precision hole is drilled for the guide.

##### 3. Initial cutting with the long type drill.

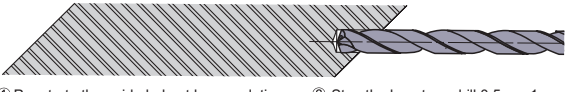

- ① Penetrate the guide hole at low revolution. (n=300), and a feed rate of Vf=1000
- ② Stop the long type drill 0,5mm-1mm short of the guide hole bottom.

##### 4. Drill the deep hole

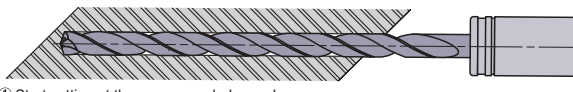

- ① Start cutting at the recommended speed and feed with a non-peck (continuous feed) cycle.

##### 5. Breaking through

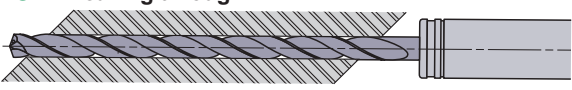

- ① When breaking through, the cutting edge can be damaged
- ② A feed rate of 0.05mm-0.1mm/rev is recommended.

##### 6. Drill retraction

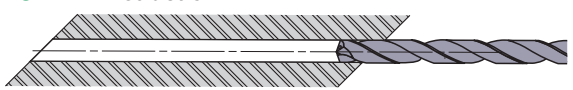

- ① Retract the drill to the pilot hole depth starting point at a feed rate of 3000mm/min.
- ② Finally clear the hole at low revolution. (n=300), and a feed rate of Vf=3000

## Recommended Cutting Conditions

### ● MPS/MSL DRILL (l/d=3–12)

Work Material	Drill Diameter	φ3.0–φ6.0		φ6.0–φ10.0		φ10.0–φ14.0		φ14.0–φ20.0	
	Conditions	Cutting Speed (m/min)	Feed (mm/rev)	Cutting Speed (m/min)	Feed (mm/rev)	Cutting Speed (m/min)	Feed (mm/rev)	Cutting Speed (m/min)	Feed (mm/rev)
	Hardness								
P Mild Steel	≤180HB	110 (50–120)	0.20 (0.15–0.25)	130 (80–140)	0.25 (0.20–0.35)	150 (90–170)	0.30 (0.20–0.40)	160 (100–180)	0.35 (0.20–0.40)
	180–280HB Carbon Steel Alloy Steel	90 (50–100)	0.20 (0.15–0.25)	110 (70–120)	0.25 (0.20–0.35)	130 (80–140)	0.25 (0.20–0.40)	140 (100–150)	0.30 (0.20–0.40)
		80 (40–90)	0.20 (0.15–0.30)	90 (60–110)	0.25 (0.15–0.30)	110 (70–130)	0.25 (0.15–0.40)	120 (90–140)	0.30 (0.20–0.40)
M Stainless Steel	≤200HB	50 (20–100)	0.10 (0.05–0.15)	60 (40–120)	0.20 (0.10–0.25)	70 (50–120)	0.25 (0.15–0.30)	80 (60–120)	0.25 (0.15–0.30)
K Cast Iron	Tensile Strength ≤350N/mm <sup>2</sup>	100 (70–120)	0.25 (0.15–0.30)	130 (100–140)	0.30 (0.20–0.35)	150 (110–160)	0.35 (0.25–0.40)	160 (120–170)	0.35 (0.25–0.40)
	Ductile Cast Iron Tensile Strength ≤450N/mm <sup>2</sup>	60 (30–80)	0.20 (0.15–0.25)	70 (40–90)	0.20 (0.15–0.30)	90 (50–110)	0.25 (0.20–0.40)	100 (60–110)	0.3 (0.20–0.40)
S Heat Resistant Alloy	—	20 (10–25)	0.10 (0.05–0.15)	25 (15–30)	0.12 (0.05–0.15)	25 (15–30)	0.15 (0.10–0.20)	30 (25–35)	0.15 (0.10–0.20)

### ● MPS/MSL DRILL (l/d=15–30)

Work Material	Drill Diameter	φ3.0–φ6.0		φ6.0–φ10.0		φ10.0–φ14.0	
	Conditions	Cutting Speed (m/min)	Feed (mm/rev)	Cutting Speed (m/min)	Feed (mm/rev)	Cutting Speed (m/min)	Feed (mm/rev)
	Hardness						
P Mild Steel	≤180HB	85 (35–100)	0.20 (0.15–0.25)	85 (45–120)	0.25 (0.15–0.35)	90 (55–120)	0.30 (0.20–0.35)
	180–280HB Carbon Steel Alloy Steel	80 (40–95)	0.20 (0.15–0.25)	90 (50–120)	0.25 (0.20–0.35)	90 (60–130)	0.30 (0.15–0.35)
		75 (35–80)	0.15 (0.15–0.20)	80 (45–115)	0.20 (0.15–0.25)	85 (55–115)	0.25 (0.15–0.30)
M Stainless Steel	≤200HB	50 (20–80)	0.10 (0.05–0.15)	60 (20–90)	0.12 (0.05–0.15)	70 (20–90)	0.15 (0.10–0.20)
K Cast Iron	Tensile Strength ≤350N/mm <sup>2</sup>	70 (40–85)	0.25 (0.15–0.30)	75 (50–90)	0.30 (0.20–0.35)	80 (50–95)	0.35 (0.20–0.40)
	Ductile Cast Iron Tensile Strength ≤450N/mm <sup>2</sup>	65 (35–80)	0.20 (0.15–0.25)	70 (45–85)	0.25 (0.15–0.30)	75 (45–90)	0.30 (0.20–0.35)
S Heat Resistant Alloy	—	20 (10–25)	0.10 (0.05–0.15)	25 (15–30)	0.12 (0.05–0.15)	25 (15–30)	0.15 (0.10–0.20)

Machining conditions can vary greatly, please use the above tables as a reference starting point only and adjust the values according to the conditions. For drill lengths greater than l/d=10 it is recommended to drill a pilot hole.



[www.mitsubishicarbide.com](http://www.mitsubishicarbide.com)

**MMC HARTMETALL GmbH**  
Comeniusstr. 2, 40670 Meerbusch, Germany  
Tel. +49-2159-91890 Fax +49-2159-918966  
e-mail marketing@mmchg.de

**MITSUBISHI MATERIALS ESPAÑA, S.A.**  
C/Emperador 2, 46136 Museros, Valencia, Spain  
Tel. +34-96-144-1711 Fax +34-96-144-3786  
e-mail mme@mmevalencia.com

**MITSUBISHI HARDMETAL RUSSIA OOO LTD.**  
ul. Bolschaja Pochtovaja, d.36, str.1 105082 Moscow, Russia  
Tel. +007-095-72558-85 Fax +007-095-72558-85  
e-mail mmc-moscow@lescom.ru

**MMC HARDMETAL U.K. LTD.**  
Mitsubishi House, Galena Close, Tamworth, B77 4AS, U.K.  
Tel. +44-1827-312312 Fax +44-1827-312314  
e-mail sales@mitsubishicarbide.co.uk

**MMC ITALIA S.r.l.**  
V.le delle Industrie 20/5, 20020 Arese (Mi)  
Tel. +39-02 93 77 03 1 Fax +39-02 93 58 90 93  
e-mail info@mmc-italia.it

**MMC METAL FRANCE S.A.R.L.**  
6, rue Jacques Monod, 91893 Orsay Cedex, France  
Tel. +33-1-69 35 53 53 Fax +33-1-69 35 53 50  
e-mail mmfsales@mmc-metal-france.fr

**MMC HARDMETAL POLAND Sp. z o.o.**  
Armii Karjowej 61, Wrocław, Poland  
Tel. +48-71-3351-620 Fax +48-71-3351-620  
e-mail mmc@mhpl.pl